

- > Ø 20 ... 125 mm
 - > Conforms to ISO 21287
 - > M/50 switches can be mounted flush with the profile
 - > Magnetic piston as standard
 - > Seals ensure low friction operation and long life
- > Three different guiding systems:
RA/192000/N2, .../N4 or .../N6

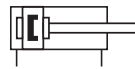

Technical features

Medium:

Compressed air, filtered, lubricated or non-lubricated

Standard:

Based on ISO 21287

Operation:

RA/192000/M: Double acting, magnetic piston, male piston rod thread, buffer cushioning

RA/192000/MX: Double acting, magnetic piston, female piston rod thread, buffer cushioning

Operating pressure:

1 ... 10 bar (14 ... 145 psi)

Ports:

M5, G1/8 ... G1/4

Cylinder diameters:

20, 25, 32, 40, 50, 63, 80, 100 and 125 mm

Standard Strokes:

See below

Operating temperature:

-5 ... +80°C max. (+23 ... +176°F)

Air supply must be dry enough to avoid ice formation at temperatures below +2°C (+35°F).

Materials:

Profile barrel: Anodized aluminium
End covers: Pressure diecast aluminium
Piston rod: Stainless steel
Piston rod seals: PUR
Piston seals: NBR
O-rings: NBR

Technical data

Cylinder Ø (mm)	20	25	32	40	50	63	80	100	125
Port size	M 5	M 5	G 1/8	G 1/8	G 1/8	G 1/8	G 1/8	G 1/8	G 1/4
Piston rod Ø (mm)	10	10	12	16	20	20	25	25	32
Piston rod thread	M8x1,25	M8x1,25	M10x1,25	M10x1,25	M12x1,25	M12x1,25	M16x1,5	M16x1,5	M27x2
Energy (J) max.	0,2	0,3	0,45	0,75	1,1	1,3	1,9	2,3	3
Theoretical thrusts at 6 bar outstroke (N)	188	294	482	754	1178	1870	3016	4710	7363
Theoretical thrusts at 6 bar instroke (N)	141	247	414	633	990	1680	2722	4416	6882
Air consumption at 6 bar outstroke (l/cm)	0,022	0,035	0,056	0,088	0,137	0,218	0,35	0,55	0,86
Air consumption at 6 bar instroke (l/cm)	0,016	0,028	0,048	0,074	0,114	0,195	0,32	0,51	0,79

Technical data, RA/1920xx/TM.

For Model only RA/1920xx/TM..	20	25	32	40	50	63	80	100
Energy (J) max.	0,2	0,3	0,45	0,75	1,1	1,3	1,9	2,3
Theoretical thrusts at 6 bar outstroke (N)	330	542	897	1387	2168	3552	3737	9130
Theoretical thrusts at 6 bar instroke (N)	141	247	414	633	990	1680	2722	4416
Air consumption at 6 bar outstroke (l/cm)	0,038	0,063	0,105	0,162	0,253	0,414	0,669	1,065
Air consumption at 6 bar instroke (l/cm)	0,016	0,028	0,048	0,074	0,114	0,195	0,32	0,51

Standard strokes

Cylinder Ø (mm)	Stroke length (mm)										
	5	10	15	20	25	30	40	50	60	80	100
32	•	•	•	•	•	•	•	•	—	—	—
40	•	•	•	•	•	•	•	•	—	—	—
50	—	•	•	•	•	•	•	•	•	•	•
63	—	—	•	•	•	•	•	•	•	•	•
80	—	—	•	•	•	•	•	•	•	•	•
100	—	—	•	•	•	•	•	•	•	•	•
125	—	—	•	•	•	•	•	•	•	•	•

Cylinder variants

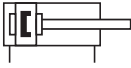
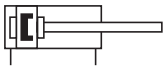
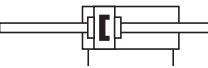
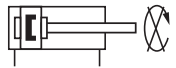
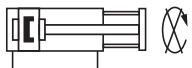
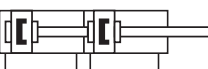
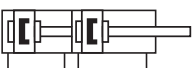
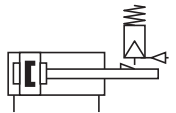
Symbol	T	S	Model with magnetic piston	Description	Dimensions Page
	•	•	RA/192000/M	Standard cylinder, male piston rod thread *1)	7
	•	•	RA/192000/MX	Standard cylinder, female piston rod thread *1)	7
	•	•	RA/192000/W2	Special wiper/seal, male piston rod thread, Ø 20 ... 125 mm	7
	•	•	RA/192000/W2X	Special wiper/seal, female piston rod thread, Ø 20 ... 125 mm	7
	•	•	RA/192000/X4	Low friction cylinders, male piston rod thread, Ø 32 ... 100 mm Medium: compressed air, filtered and non-lubricated recommended, 0,2 ... 10 bar	7
	•	•	RA/192000/X4X	Low friction cylinders, female piston rod thread, Ø 32 ... 100 mm, Medium: compressed air, filtered and non-lubricated recommended, 0,2 ... 10 bar	7
	•	•	RA/192000/MU	Cylinder with extended piston rod, male piston rod thread	7
	•	•	RA/192000/MUX	Cylinder with extended piston rod, female piston rod thread	7
	•	•	RA/192000/JM	Cylinder with double ended piston rod, male piston rod thread *1)	8
	•	•	RA/192000/JMX	Cylinder with double ended piston rod, female piston rod thread *1)	8
	•	•	RA/192000/N2	Cylinder with non-rotating piston rod (internal), male piston rod thread, Ø 20 ... 100 mm	7
	•	•	RA/192000/N2X	Cylinder with non-rotating piston rod (internal), female piston rod thread, Ø 20 ... 100 mm	7
	•	•	RA/192000/N4	Cylinder with guiding, Ø 20 ... 100 mm Ø 20 and 25 mm max. stroke 80 mm, Ø 32 ... 100 mm max. stroke 100 mm	8
	•	•	RA/192000/N6	Cylinder with external guiding, Ø 25 and 32 mm Standard strokes 25, 50, 75 and 100 mm only	9
	•	•	RA/192000/TM	Tandem cylinder (double drive), male piston rod thread, Ø 20 ... 100 mm	9
	•	•	RA/192000/TMX	Tandem cylinder (double drive), female piston rod thread, Ø 20 ... 100 mm	9
	•	•	RA/192000/SM	Multi-Position cylinder, male piston rod thread, Ø 20 ... 100 mm	10
	•	•	RA/192000/SMX	Multi-Position cylinder, female piston rod thread, Ø 20 ... 100 mm	10
	•	•	RA/192000/L4	Cylinder with locking unit (passive) and male piston rod thread, Ø 32 ... 125 mm Locking is achieved by spring force on removal of the signal ... the unit, Operating pressure for locking unit: 4 ... 10 bar	10
	•	•	RA/192000/L4X	Cylinder with locking unit (passive) and female piston rod thread, Ø 32 ... 125 mm Locking is achieved by spring force on removal of the signal ... the unit, Operating pressure for locking unit: 4 ... 10 bar	10

For cylinder variants T, and S see options selector

Alternative variants without magnetic piston (Ø 63 ... 125 mm) on request.

*1) Variant T: Ø 20 ... 100 mm; max. stroke length 200 mm

Option selector
★★A/192★★/★★/★★

Special variants	Substitute
High temperature version: 150°C max.	T
Piston rod materials	Substitute
Stainless steel martensitic (1.4021)	R
Stainless steel austenitic (1.4305)	S
Cylinder Ø (mm)	Substitute
20	020
25	025
32	032
40	040
50	050
63	063
80	080
100	100
125	125

Note: If option is not required, disregard option position within part number eg. RA/192100/M/100. For combinations of cylinder variants consult our technical service.

Please note that heat resistant seals are not available for all variants.

This options selector explains only the cylinder variants.

Additional variants/options can not be derived from.

Strokes (mm)	Substitute
Ø 20 and 25	5 < 200
Ø 32 and 40	5 < 300
Ø 50 and 63	10 < 400
Ø 80 to 125	15 < 500
Piston rod thread	Substitute
Female	X
Male	None
Variants (magnetic piston)	Substitute
Standard	M
Double ended piston rod	JM
Non-rotating piston rod (internal)	N2
Guiding	N4
Special wiper/seal	W2
Locking unit	L4
External guiding	N6
Extended piston rod	MU
RA/192***/MU*/***/***/	
	Extension (mm)
Low friction	X4
Tandem cylinder	TM
Multi-position cylinder	SM
RA/192***/SM*/***/***/	
	Rear cylinder stroke
	Front cylinder stroke



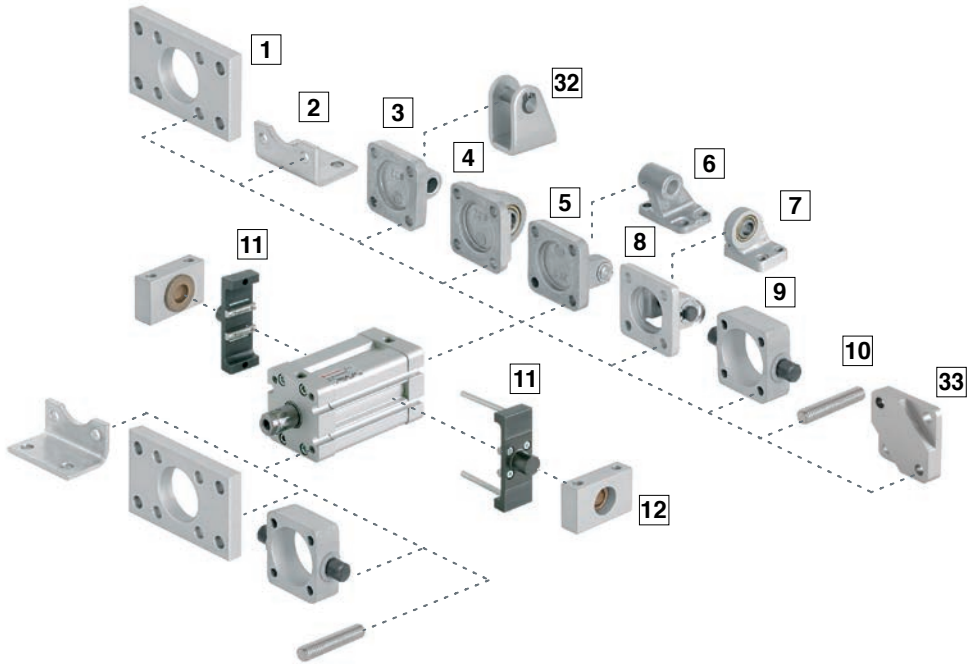



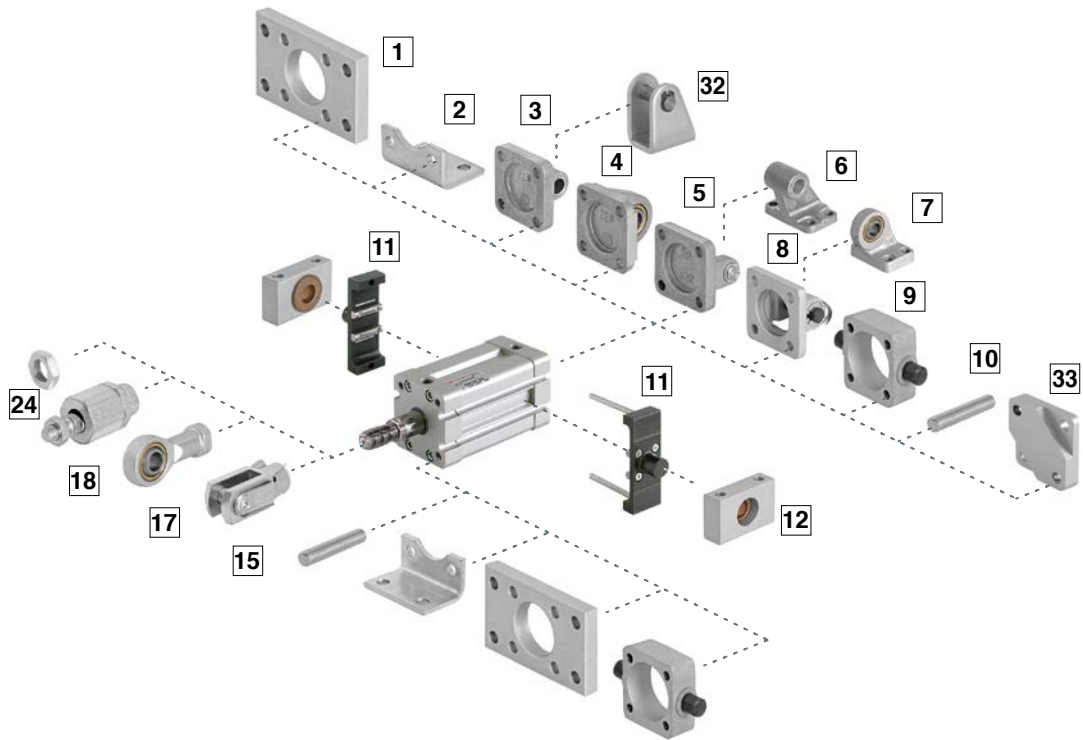







Series RA/192000/MX









Series RA/192000/M



Mountings

Model	A	B, G	C	D	D2	FH	L2
							
	10	1	2	5	8	9	32
Ø	Page 11	Page 11	Page 11	Page 12	Page 12	Page 12	Page 13
20	—	QA/192020/22	QM/192020/21	—	—	—	QM/8020/44
25	—	QA/192025/22	QM/192025/21	—	—	—	QM/8020/44
32	QM/8032/35	QA/8032/22	QA/192032/21	QA/8032/23	QA/8032/42	QA/8032/34	—
40	QM/8032/35	QA/8040/22	QA/192040/21	QA/8040/23	QA/8040/42	QA/8040/34	—
50	QM/8050/35	QA/8050/22	QA/192050/21	QA/8050/23	QA/8050/42	QA/8050/34	—
63	QM/8050/35	QA/8063/22	QA/192063/21	QA/8063/23	QA/8063/42	QA/8063/34	—
80	QM/8080/35	QA/8080/22	QA/192080/21	QA/8080/23	QA/8080/42	QA/8080/34	—
100	QM/8080/35	QA/8100/22	QA/192100/21	QA/8100/23	QA/8100/42	QA/8100/34	—
125	QM/8125/35	QM/8125/22	QM/8125/21	QM/8125/23	QA/8125/42	QA/8125/34	—
Model	R	S	SW	UH	UR	US	Assembly Kit
							
	3	12	6	1	4	7	33
Ø	Page 12	Page 13	Page 14	Page 13	Page 13	Page 14	Page 15
20	QM/192020/27	—	—	—	—	—	QA/192020/55
25	QM/192025/27	—	—	—	—	—	QA/192025/55
32	QA/8032/27	QA/8032/41	M/P19493	PQA/182032/40	QA/8032/33	M/P40310	QA/192032/55
40	QA/8040/27	QA/8040/41	M/P19494	PQA/182040/40	QA/8040/33	M/P40311	QA/192040/55
50	QA/8050/27	QA/8040/41	M/P19495	PQA/182050/40	QA/8050/33	M/P40312	QA/192050/55
63	QA/8063/27	QA/8063/41	M/P19496	PQA/182063/40	QA/8063/33	M/P40313	QA/192063/55
80	QA/8080/27	QA/8063/41	M/P19497	PQA/182080/40	QA/8080/33	M/P40314	QA/192080/55
100	QA/8100/27	QA/8100/41	M/P19498	PQA/182100/40	QA/8100/33	M/P40315	QA/192100/55
125	QM/8125/27	QA/8100/41	M/P19499	PQA/182125/40	QM/8125/33	M/P71355	QA/192125/55

For cylinders with male piston rod thread
Accessories

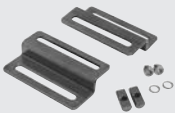
Model	AK	F	N2	UF	Groove cover	Magnetically operated switches	Groove key	Valve mounting kit
								
	18	15	24	17				
Ø	Page 11	Page 12	Page 13	Page 12	Page 15	Page 16 & 17	Page 15	Page 15
20	QM/8020/38	QM/8020/25	M/P1501/60	QM/8020/32	M/P72725/1000		M/P72816	—
25	QM/8020/38	QM/8020/25	M/P1501/60	QM/8020/32	M/P72725/1000		M/P72816	—
32	QM/8025/38	QM/8025/25	M/P1501/89	QM/8025/32	M/P72725/1000		M/P72816	—
40	QM/8025/38	QM/8025/25	M/P1501/89	QM/8025/32	M/P72725/1000		M/P72816	—
50	QM/8040/38	QM/8040/25	M/P1501/90	QM/8040/32	M/P72725/1000		M/P72816	QA/180050/22/54
63	QM/8040/38	QM/8040/25	M/P1501/90	QM/8040/32	M/P72725/1000		M/P72816	QA/180050/22/54
80	QM/8050/38	QM/8050/25	M/P1501/91	QM/8050/32	M/P72725/1000		M/P72816	QA/180080/22/54
100	QM/8050/38	QM/8050/25	M/P1501/91	QM/8050/32	M/P72725/1000		M/P72816	QA/180080/22/54
125	QM/8125/38	QM/8125/25	M/P1501/105	QM/8125/32	M/P72725/1000		M/P72816	QA/180080/22/54

Service kit

Service kit					
					
Ø	Ø	Ø	Ø	Ø	Ø
20	QM/192020/00	40	QM/192040/00	80	QM/192080/00
25	QM/192025/00	50	QM/192050/00	100	QM/192100/00
32	QM/192032/00	63	QM/192063/00	125	QM/192125/00

RA/192000/M. – Standard cylinder
RA/192000/N2. – Cylinder with non-rotating piston rod
Side load

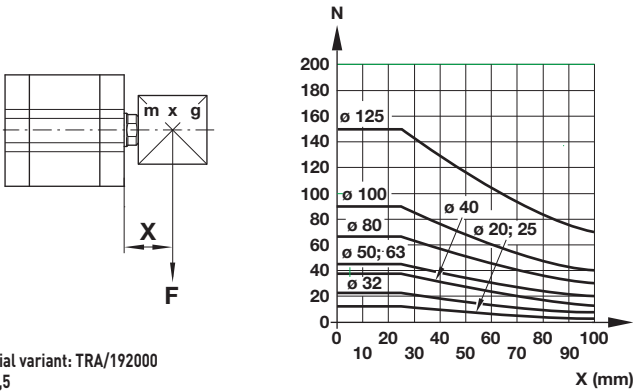

Special variant: TRA/192000
F x 0,5

Ø	Torque max. (Nm)	Model
20	0,15	RA/192020/M. RA/192020/N2.
25	0,25	RA/192025/M. RA/192025/N2.
32	0,4	RA/192032/M. RA/192032/N2.
40	0,75	RA/192040/M. RA/192040/N2.
50	1,5	RA/192050/M. RA/192050/N2.
63	1,5	RA/192063/M. RA/192063/N2.
80	2,5	RA/192080/M. RA/192080/N2.
100	2,5	RA/192100/M. RA/192100/N2.

RA/192000/JM – Cylinder with double ended piston rod
Side load

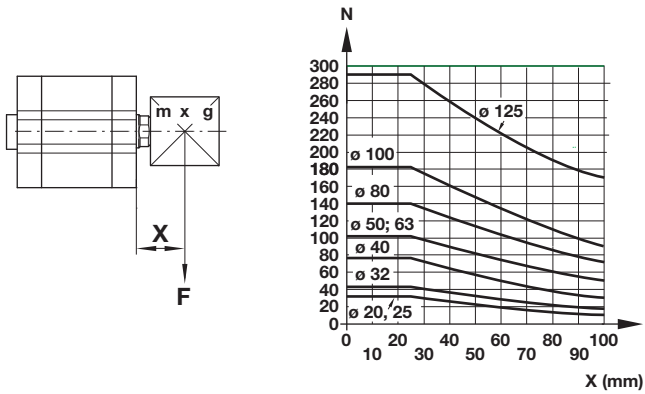

RA/192000/N6 – Cylinder with external guiding
Side load

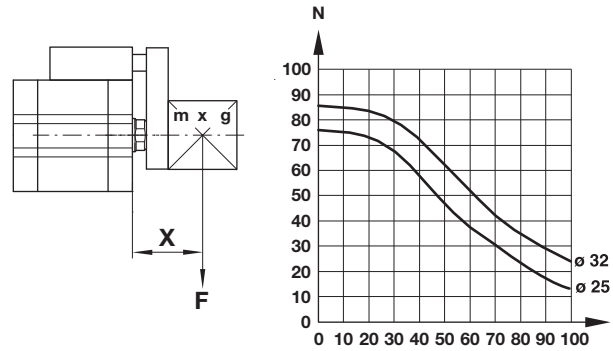

RA/192000/N4 – Cylinder with guiding
Side load

Side load

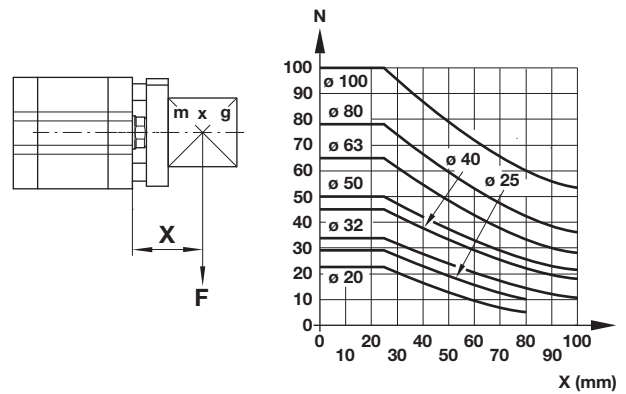
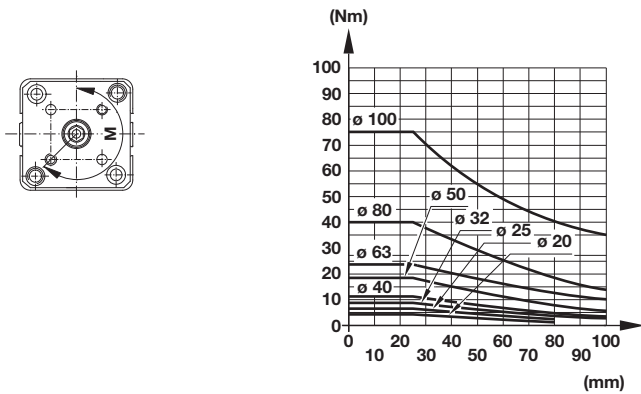

Dimensions
RA/192000/MX – Standard cylinder
With female piston rod thread

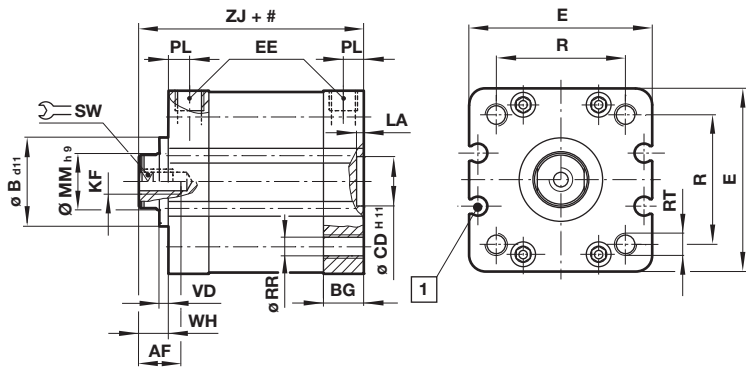

Dimensions
RA/192000/M – Standard cylinder
With male piston rod thread

Dimensions in mm
Projection/First angle

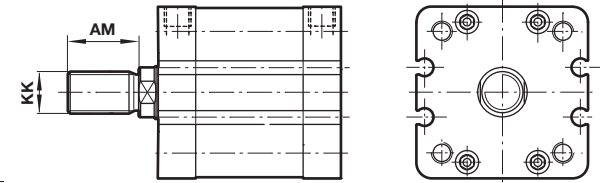

Stroke

1 M/50 switches can be mounted flush with the profile

Ø	AF	AM	Ø B d11	BG	Ø CD H11	□ E	EE	KF	KK	LA	Ø MM h9	PL
20	10	16	—	12	10	37	M 5	M6	M8x1,25	2,5	10	7
25	10	16	—	13	10	41	M 5	M6	M8x1,25	2,5	10	7
32	12	19	—	14,5	14	48	G 1/8	M8	M10x1,25	2,5	12	7,5
40	12	19	—	14,5	14	54,5	G 1/8	M8	M10x1,25	2,5	16	7,5
50	16	22	—	14	18	66	G 1/8	M10	M12x1,25	2,5	20	7,5
63	16	22	—	14	18	76	G 1/8	M10	M12x1,25	2,5	20	7,5
80	20	28	—	15,5	23	96	G 1/8	M12	M16x1,5	3	25	7,5
100	20	28	—	21,5	26	116	G 1/8	M12	M16x1,5	3	25	10,5
125	30	54	60	20,5	28	142	G 1/4	M20	M27x2	3	32	10,5
Ø	□ R	Ø RR	RT	SW	VD	WH	ZJ	kg at 0 mm	kg per 5 mm	Model		
20	22	4,3	M5	8	—	6	43	0,12	0,01	RA/192020/.		
25	26	4,3	M5	8	—	6	45	0,15	0,01	RA/192025/.		
32	32,5	5,3	M6	10	—	7	51	0,23	0,02	RA/192032/.		
40	38	5,3	M6	13	—	7	52	0,30	0,02	RA/192040/.		
50	46,5	6,8	M8	17	—	8	53	0,46	0,03	RA/192050/.		
63	56,5	6,8	M8	17	—	8	57	0,70	0,03	RA/192063/.		
80	72	8,6	M10	22	—	10	64	1,23	0,04	RA/192080/.		
100	89	8,6	M10	22	—	10	77	2,20	0,05	RA/192100/.		
125	110	10,6	M12	27	4	18	89	3,60	0,07	RA/192125/.		

Cylinder variants

RA/192000/N2X – Cylinder with non-rotating piston rod
With female piston rod thread

RA/192000/N2 – Cylinder with non-rotating piston rod
With male piston rod thread

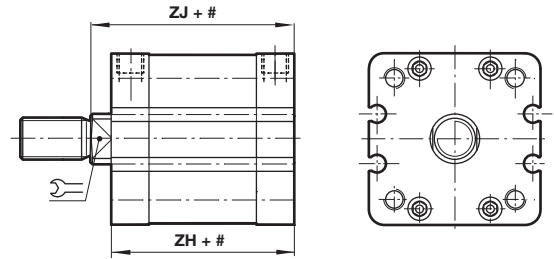
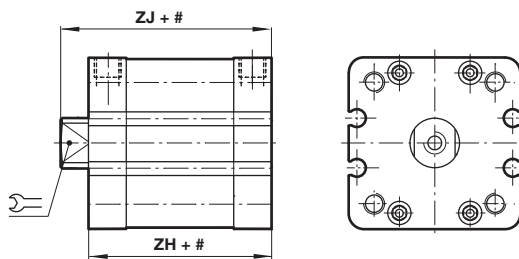

Stroke

Ø	SW	ZH	ZJ	kg at 0 mm	kg per 5 mm	Model
20	8	47	53	0,12	0,01	RA/192020/N2.
25	8	49	55	0,15	0,01	RA/192025/N2.
32	10	54	61	0,23	0,02	RA/192032/N2.
40	13	55	62	0,30	0,02	RA/192040/N2.
50	16	55	63	0,46	0,03	RA/192050/N2.
63	16	59	67	0,70	0,03	RA/192063/N2.
80	21	64	74	1,23	0,04	RA/192080/N2.
100	21	77	87	2,20	0,05	RA/192100/N2.

Note: The basic length of the RA/192000/N2 version is slightly longer than the standard.

RA/192000/JMX
Cylinder with double ended piston rod
With female piston rod thread

RA/192000/JM
Cylinder with double ended piston rod
With male piston rod thread

Dimensions in mm
Projection/First angle

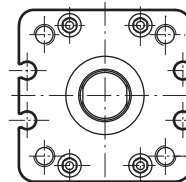
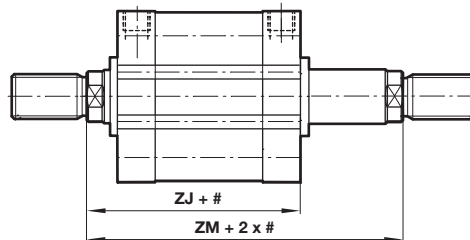
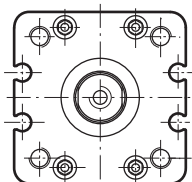
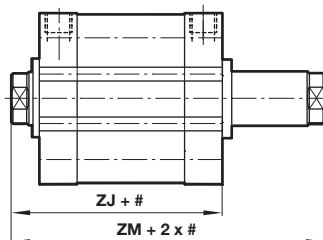

Ø	ZJ	ZM	kg at 0 mm	kg per 5 mm	Model
20	43	49	0,15	0,01	RA/192020/JM.
25	45	51	0,18	0,01	RA/192025/JM.
32	51	58	0,28	0,02	RA/192032/JM.
40	52	59	0,35	0,02	RA/192040/JM.
50	53	61	0,52	0,03	RA/192050/JM.
63	57	65	0,76	0,03	RA/192063/JM.
80	64	74	1,30	0,04	RA/192080/JM.
100	77	87	2,30	0,05	RA/192100/JM.
125	89	107	3,75	0,07	RA/192125/JM.

Stroke

RA/192000/N4 – Cylinder with guiding

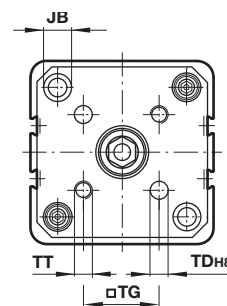
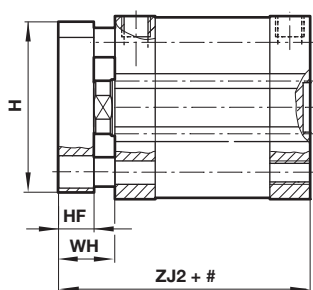
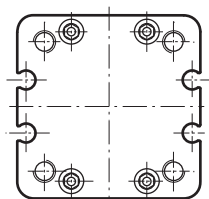

Stroke

Ø	H	HF	Ø JB	Ø TDH8	... TG	TT	WH	ZJ2	kg at 0 mm	kg per 5 mm	Model
20	34	8	7,5	4	12	M4	14	51	0,17	0,01	RA/192020/N4
25	38	8	7,5	5	15,6	M5	14	53	0,23	0,01	RA/192025/N4
32	45	10	9	5	19,8	M5	17	61	0,33	0,02	RA/192032/N4
40	51	10	9	5	23,3	M5	17	62	0,45	0,02	RA/192040/N4
50	62,5	12	11	6	29,7	M6	20	65	0,65	0,03	RA/192050/N4
63	72	12	11	6	35,4	M6	20	69	0,95	0,03	RA/192063/N4
80	92	15	15	8	46	M8	25	79	1,70	0,04	RA/192080/N4
100	112	15	15	10	56,5	M10	25	92	3,10	0,05	RA/192100/N4

RA/192000/N6 – Cylinder with external guiding

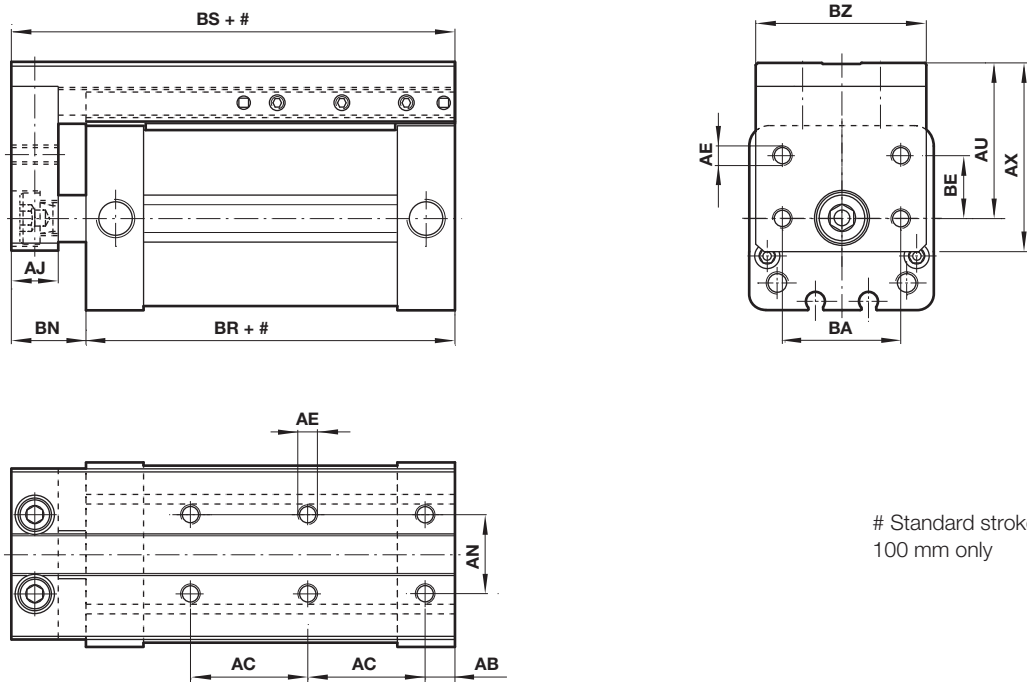
 Dimensions in mm
Projection/First angle

Standard strokes 25, 50, 75 and 100 mm only

Ø	AB	AC	AE	AJ	AN	AU	AX	BA	BE	BN	BR	BS	BZ	at 0 mm	per 5 mm	Model
25	7,5	30	M5	12	20	37,5	44	30	16	18	39	57	43,5	0,31 kg	0,09 kg	RA/192025/N6
32	7,5	30	M5	12	20	40,5	48,5	30	16	19	44	63	43,5	0,44 kg	0,12 kg	RA/192032/N6

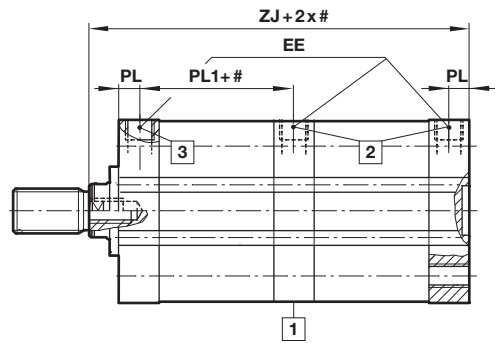
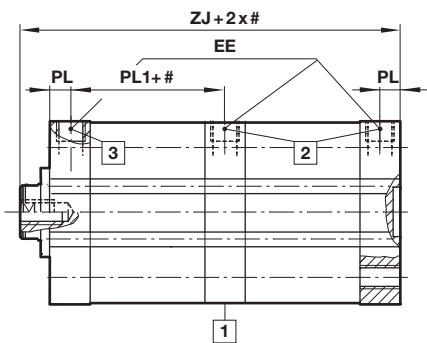
**RA/192000/TMX – Tandem cylinder
with female piston rod thread**
**RA/192000/TM – Tandem cylinder
with male piston rod thread**

Ø	EE	PL	PL1	ZJ	kg at 0 mm	kg per 5 mm	Model
20	M5	7	25,5	68	0,21	0,01	RA/192020/TM.
25	M5	7	26,5	71	0,26	0,01	RA/192025/TM.
32	G 1/8	7,5	30	81	0,39	0,02	RA/192032/TM.
40	G 1/8	7,5	31	83	0,51	0,02	RA/192040/TM.
50	G 1/8	7,5	31	85	0,78	0,03	RA/192050/TM.
63	G 1/8	7,5	36	94	1,21	0,03	RA/192063/TM.
80	G 1/8	7,5	40	104	2,11	0,04	RA/192080/TM.
100	G 1/8	10,5	45,5	122	3,68	0,05	RA/192100/TM.

Stroke

1 Exhaust port

Note: Do not cover this area!

2 Pressure »outstroke«

3 Pressure »instroke«

RA/192000/SMX – Multi position cylinder
with female piston rod thread

RA/192000/SM – Multi position cylinder
with male piston rod thread

Dimensions in mm
Projection/First angle

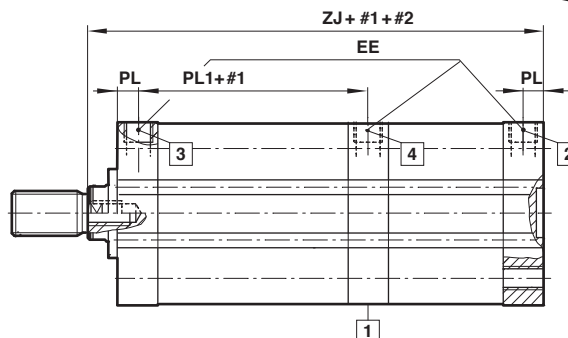
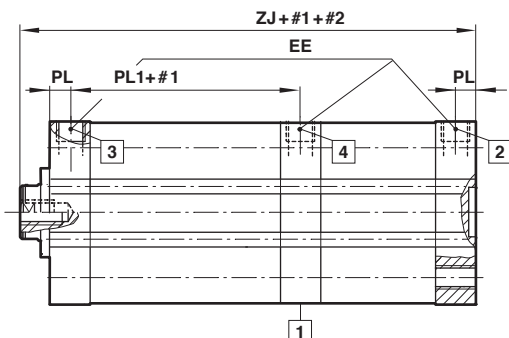

Ø	EE	PL	PL1	ZJ	kg at 0 mm	kg per 5 mm	Model
20	M5	7	25,5	68	0,21	0,01	RA/192020/SM.
25	M5	7	26,5	71	0,26	0,01	RA/192025/SM.
32	G 1/8	7,5	30	81	0,39	0,02	RA/192032/SM.
40	G 1/8	7,5	31	83	0,51	0,02	RA/192040/SM.
50	G 1/8	7,5	31	85	0,78	0,03	RA/192050/SM.
63	G 1/8	7,5	36	94	1,21	0,03	RA/192063/SM.
80	G 1/8	7,5	40	104	2,11	0,04	RA/192080/SM.
100	G 1/8	10,5	45,5	122	3,68	0,05	RA/192100/SM.

1 Exhaust port
Note: Do not cover this area!

#1 Stroke front cylinder
#2 Stroke rear cylinder
Note: Stroke (#1) > stroke (#2)

2 Pressure »outstroke« rear cylinder
3 Pressure »instroke«
4 Pressure »outstroke« front cylinder

RA/192000/L4X – Cylinder with locking unit
female piston rod thread

RA/192000/L4 – Cylinder with locking unit
male piston rod thread

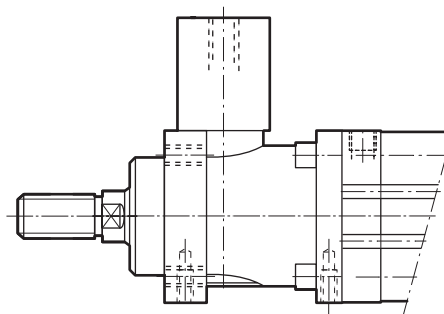
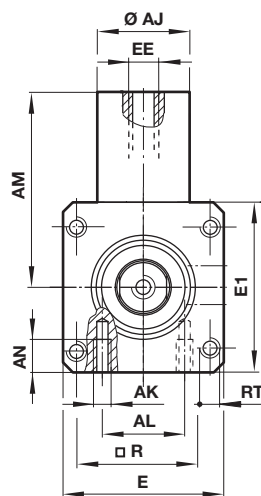
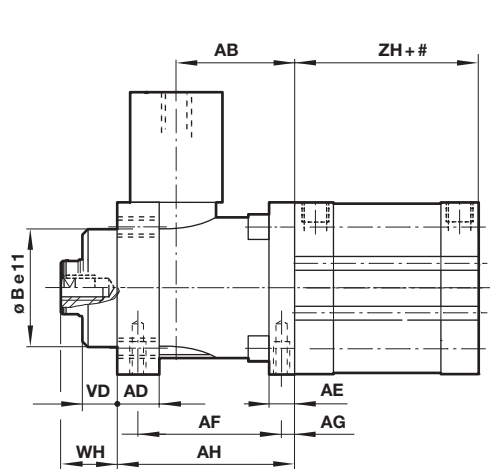

Stroke

Ø	AB	AD	AE	AF	AG	AH	Ø AJ	AK	AL	AM	AN	Be11	E	E 1
32	32	12	8	40	4,2	48	25	M5	16	49	8	30	48	50
40	35,5	12	10	46	4,5	55	24	M5	21	61,5	10	35	56	58
50	49	16	15	54	11,5	70	30	M6	24	75	12	40	68	70
63	49	15	15	55	7,5	70	38	M8	32	86	12	45	82	85
80	62	16	16	70	10	90	53	M8	44	119	16	45	100	105
100	65	18	16	70	10	92	48	M8	60	119	16	55	120	130
125	85	27	25	95	11	122	65	M10	75	140	20	60	140	150
Ø	EE	R	RT	VD	WH	ZH	Locking force	kg at 0 mm	kg per 5 mm	Model				
32	M 5	32,5	M 6	10	16	44	600 N	0,53	0,02	RA/192032/L4.				
40	G 1/8	38	M 6	10	18	45	1000 N	0,70	0,02	RA/192040/L4.				
50	G 1/8	46,5	M 8	12	22	45	1500 N	1,26	0,03	RA/192050/L4.				
63	G 1/8	56,5	M 8	12	20	49	2200 N	1,90	0,03	RA/192063/L4.				
80	G 1/8	72	M 10	20	33	54	5000 N	3,80	0,04	RA/192080/L4.				
100	G 1/8	89	M 10	23	38	67	5000 N	5,90	0,05	RA/192100/L4.				
125	G 1/8	110	M 12	32	65	71	7000 N	10,10	0,07	RA/192125/L4.				

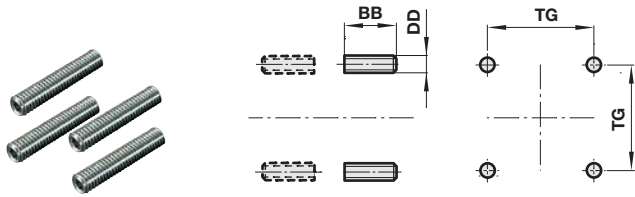
Mountings
Front or rear stud mounting A
Conforms to ISO 15552, type MX1

Ø	BB	DD	TG	kg	Model (A)
32/40	17	M6	32,5/38	0,02	QM/8032/35
50/63	23	M8	46,5/56,5	0,05	QM/8050/35
80/100	28	M10	72/89	0,08	QM/8080/35
125	34	M12	110	0,14	QM/8125/35

Piston rod swivel AK

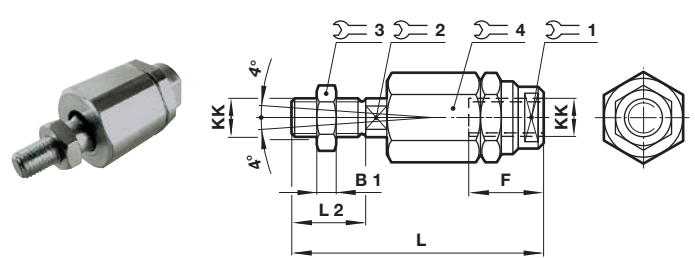
 Dimensions in mm
Projection/First angle

Ø	KK	B1	F	L	L2	1 2 3 4				kg	Model (AK)
						1	2	3	4		
20/25	M8x1,25	4	18	55	16	10	7	13	17	0,05	QM/8020/38
32/40	M10x1,25	5	26	73	20	19	12	17	30	0,20	QM/8025/38
50/63	M12x1,25	6	26	77	24	19	12	19	30	0,20	QM/8040/38
80/100	M16x1,5	8	34	106	32	30	19	24	42	0,65	QM/8050/38
125	M27x2	13,5	40	147	54	40	24	41	55	1,70	QM/8125/38

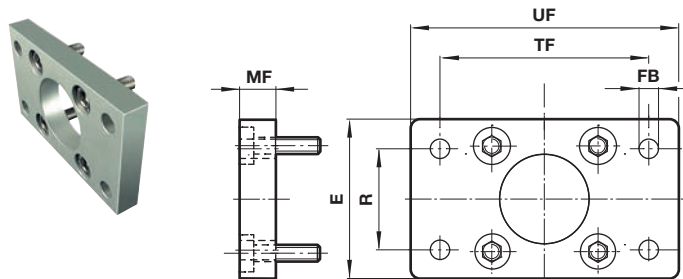
Front flange B, Front flange G
**Conforms to ISO 21 287 (Ø 20 and 25 mm) and
ISO 15552 (Ø 32 to 125 mm), type MF1 and MF2**

Ø	E	Ø FB	MF	R	TF	UF	kg	Model (B/G)
20	36	6,6	8	-	55	70	0,16	QA/192020/22
25	40	6,6	8	-	60	76	0,2	QA/192025/22
32	50	7	10	32	64	80	0,25	QA/8032/22
40	55	9	10	36	72	90	0,35	QA/8040/22
50	65	9	12	45	90	110	0,7	QA/8050/22
63	75	9	12	50	100	125	0,8	QA/8063/22
80	100	12	16	63	126	154	1,35	QA/8080/22
100	120	14	16	75	150	186	2,2	QA/8100/22
125	140	16	20	90	180	224	2,7	QM/8125/22

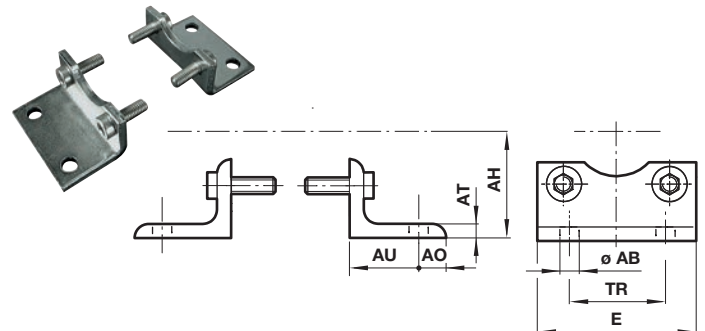
Foot C
Conforms to ISO 15552, type MS1

Ø	Ø AB	AH	AO	AT	AU	E	TR	kg	Model (C)
20	7	27	6	4	16	36	22	0,03	QM/192020/21
25	7	29	7	4	16	40	26	0,04	QM/192025/21
32	7	33,5	7	4	16	48	32	0,15	QA/192032/21
40	10	38	9	4	18	54,5	36	0,18	QA/192040/21
50	10	45	9	5	21	66	45	0,3	QA/192050/21
63	10	50	9	5	21	76	50	0,39	QA/192063/21
80	12	63	11	6	26	96	63	0,8	QA/192080/21
100	14,5	74	13	6	27	116	75	0,95	QA/192100/21
125	16	90	20	9	45	140	90	2,4	QM/8125/21

Rear clevis D
Conforms to ISO 15552, type MP2

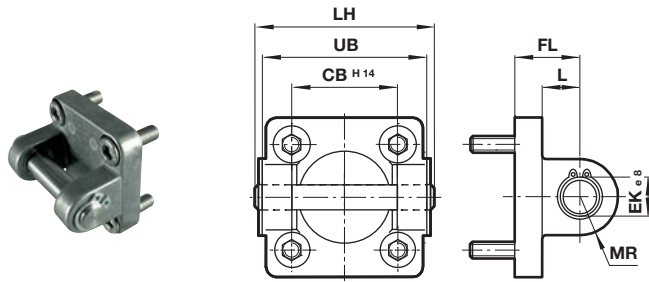

Ø	CB H14	Ø EK e8	FL	L	LH	MR	UB	kg	Model (D)
32	26	10	22	13	52	9	45	0,11	QA/8032/23
40	28	12	25	16	60	12	52	0,16	QA/8040/23
50	32	12	27	17	68	12	60	0,22	QA/8050/23
63	40	16	32	22	79	15	70	0,34	QA/8063/23
80	50	16	36	22	99	15	90	0,54	QA/8080/23
100	60	20	41	27	119	20	110	0,90	QA/8100/23
125	70	25	50	31	139	25	130	2,70	QM/8125/23

Rear clevis D2
Conforms to ISO 15552, type AB6

Dimensions in mm
Projection/First angle

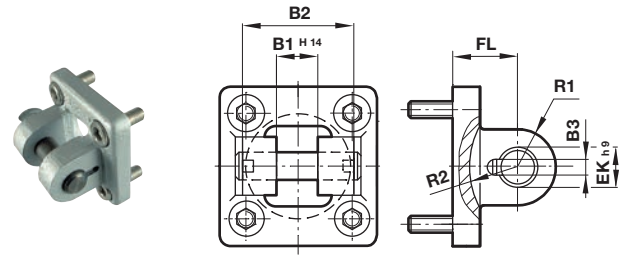

Ø	B1 H14	B2	B3	Ø EK h9	FL	R1	R2	kg	Model (D2)
32	14	34	3,3	10	22	11	17	0,20	QA/8032/42
40	16	40	4,3	12	25	12	20	0,23	QA/8040/42
50	21	45	4,3	16	27	14,5	22	0,36	QA/8050/42
63	21	51	4,3	16	32	18	25	0,55	QA/8063/42
80	25	65	4,3	20	36	22	30	0,90	QA/8080/42
100	25	75	4,3	20	41	22	32	1,45	QA/8100/42
125	37	97	6,3	30	50	30	42	2,7	QA/8125/42

Front or rear detachable trunnion FH
Conforms to VDMA 24562 part 2, type MT 5/6

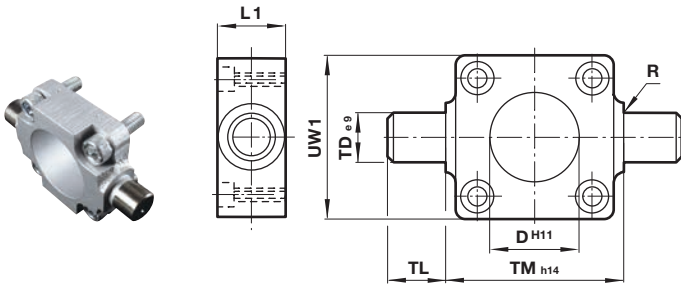

Ø	Ø D h11	L1	R	Ø TD e9	TL	TM h14	UW1	kg	Model (FH)
32	30	16	1	12	12	50	45	0,20	QA/8032/34
40	35	20	1,6	16	16	63	55	0,38	QA/8040/34
50	40	24	1,6	16	16	75	65	0,60	QA/8050/34
63	45	24	1,6	20	20	90	75	1,10	QA/8063/34
80	45	28	1,6	20	20	110	100	1,90	QA/8080/34
100	55	38	2	25	25	132	120	3,50	QA/8100/34
125	60	50	2	25	25	160	145	6,50	QA/8125/34

Piston rod clevis F
Conforms to DIN ISO 8140
For cylinders with male piston rod thread order nut,
Type N2 separately

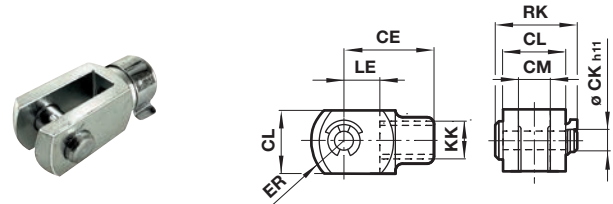

Ø	KK	CE	Ø CK h11	CL	CM	ER	LE	RK	kg	Model (F)
20/25	M8x1,25	32	8	16	8	13	16	22	0,06	QM/8020/25
32/40	M10x1,25	40	10	20	10	16	20	28	0,09	QM/8025/25
50/63	M12x1,25	48	12	24	12	19	24	32	0,13	QM/8040/25
80/100	M16x1,5	64	16	32	16	25	32	41,5	0,33	QM/8050/25
125	M27x2	110	30	55	30	45	54	62	1,35	QM/8125/25

Universal piston rod eye UF
Conforms to DIN ISO 8139
For cylinders with male piston rod thread order nut,
Type N2 separately

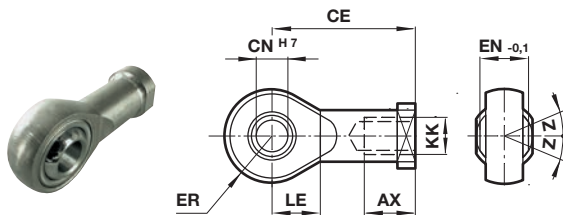

Ø	Thread KK	AX	CE	Ø CN H7	EN -0,1	ER	LE	Z	kg	Model (UF)
20/25	M8x1,25	16	36	8	12	11	13	5°	0,05	QM/8020/32
32/40	M10x1,25	20	43	10	14	14	15	13°	0,09	QM/8025/32
50/63	M12x1,25	22	50	12	16	16	17	13°	0,13	QM/8040/32
80/100	M16x1,5	28	64	16	21	21	22	15°	0,33	QM/8050/32
125	M27x2	51	110	30	37	35	36	15°	1,35	QM/8125/32

Rear eye R
Conforms to ISO 21 287 (Ø 20 and 25 mm) and
ISO 15552 (Ø 32 to 125 mm), type MP4

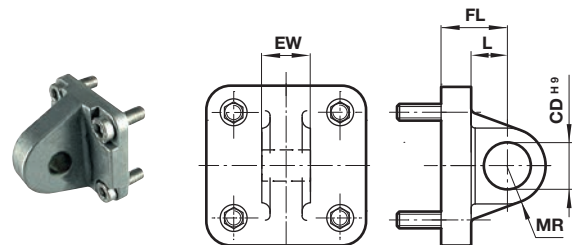

Ø	Ø CD H8	EW	FL	L	MR	kg	Model (R)
20	8	15,8	20	14	8	0,02	QM/192020/27
25	8	15,8	20	14	8	0,03	QM/192025/27
32	10	25,8	22	13	9	0,09	QA/8032/27
40	12	27,8	25	16	12	0,11	QA/8040/27
50	12	31,7	27	17	12	0,17	QA/8050/27
63	16	39,7	32	22	15	0,24	QA/8063/27
80	16	49,7	36	22	15	0,37	QA/8080/27
100	20	59,7	41	27	20	0,59	QA/8100/27
125	25	69,7	50	33	25	3,2	QM/8125/27

Adjustable trunnion mounting UH
Conforms to ISO 15552, type MT4

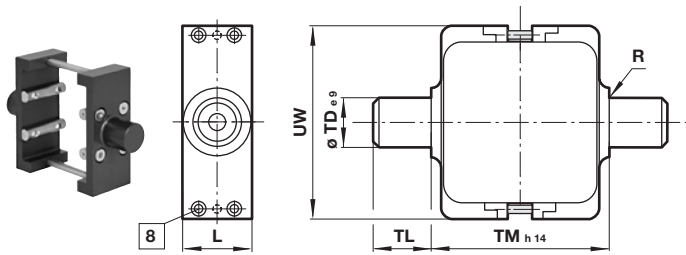

Ø	L	R	Ø De9	TL	TM h14	UW	Torque max. (Nm)	kg	Model (UH)
32	25	1	12	12	50	58	2	0,16	PQA/182032/40
40	28	1,6	16	16	63	65	3,5	0,35	PQA/182040/40
50	28	1,6	16	16	75	80	3,5	0,65	PQA/182050/40
63	36	1,6	20	20	90	96	5	0,85	PQA/182063/40
80	36	1,6	20	20	110	116	6	1,20	PQA/182080/40
100	48	2	25	25	132	140	6	2,30	PQA/182100/40
125	48	2	25	25	160	163	6	3,30	PQA/182125/40

Note: Style UH: It is most important that the locking screws which secure the mounting to the cylinder barrel are tightened to the torque figures shown in the table. For maximum energy input, consult our Technical Service.

Trunnion support S
Conforms to ISO 15552, type AT4

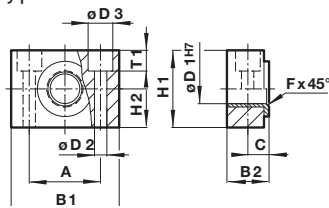

Ø	A	B1	B2	C	Ø D1h7	Ø D1	Ø D3	F x 45°	H1	H2	T1	kg	Model (S)
32	32	46	18	10,5	12	6,6	11	1	30	15,3	6,8	0,11	QA/8032/41
40/50	36	55	21	12	16	9	15	1,6	36	18	9	0,16	QA/8040/41
63/80	42	65	23	13	20	11	18	1,6	40	20	11	0,23	QA/8063/41
100/125	50	75	28,5	16	25	14	20	2	50	25	13	0,42	QA/8100/41

Nut N2
For cylinder with male piston rod thread

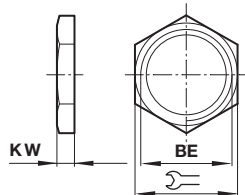

Ø	BE	KW	⌀	kg	Model(N2)
20/25	M8x1,25	4	13	0,01	M/P1501/60
32/40	M10x1,25	5	17	0,01	M/P1501/89
50/63	M12x1,25	6	19	0,01	M/P1501/90
80/100	M16x1,5	8	24	0,02	M/P1501/91
125	M27x2	13,5	41	0,09	M/P1501/105

Universal rear eye UR
Conforms to ISO 15552, type MP6

Dimensions in mm
Projection/First angle

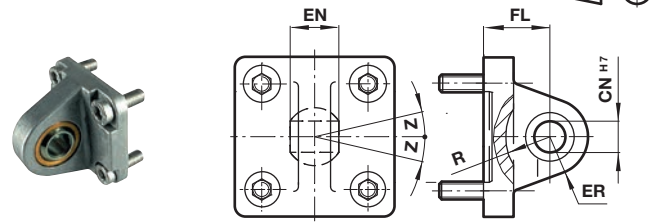

Ø	Ø CN h7	EN	ER	FL	R	Z	kg	Model (UR)
32	10	14	16	22	14,5	13°	0,15	QA/8032/33
40	12	16	18	25	18	13°	0,25	QA/8040/33
50	16	21	21	27	19	15°	0,40	QA/8050/33
63	16	21	23	32	24	15°	0,55	QA/8063/33
80	20	25	28	36	24	15°	0,90	QA/8080/33
100	20	25	30	41	29	15°	1,50	QA/8100/33
125	30	37	40	50	36	15°	2,70	QM/8125/33

Bracket hinge L2
For rear eye mounting R

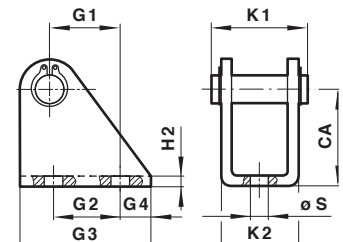

Ø	CA	G1	G2	G3	G4	H2	K1	K2	Ø S	kg	Model(L2)
20/25	30	16	20	32	6	4	29,5	24	6,6	0,08	QM/8020/44

Wide hinge SW
Conforms to ISO 15552, type AB7

Dimensions in mm
Projection/First angle

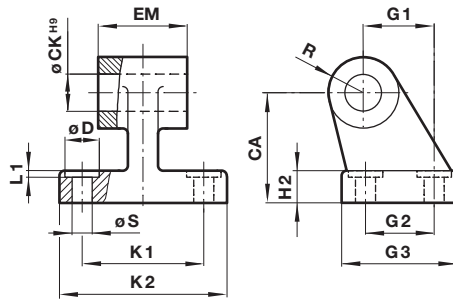

Ø	CA	Ø CK H9	Ø D	H2	EM	G1	G2	G3	K1	K2	L1	R	Ø S	kg	Model (SW)
32	32	10	11	7	25,5	21	18	31	38	50	1,6	10	6,6	0,05	M/P19493
40	36	12	11	9	27,5	24	22	35	41	54	1,6	11	6,6	0,07	M/P19494
50	45	12	15	11	31,5	33	30	45	50	65	1,6	13	9	0,14	M/P19495
63	50	16	15	12	39,5	37	35	50	52	67	1,6	15	9	0,18	M/P19496
80	63	16	18	14	49,5	47	40	60	66	84	2,5	15	11	0,28	M/P19497
100	71	20	18	15	59,5	55	50	70	76	94	2,5	19	11	0,42	M/P19498
125	90	25	20	20	70,5	70	60	90	94	124	3,2	22	14	2,70	M/P19499

Swivel hinge US
Conforms to VDMA 24562 part 2

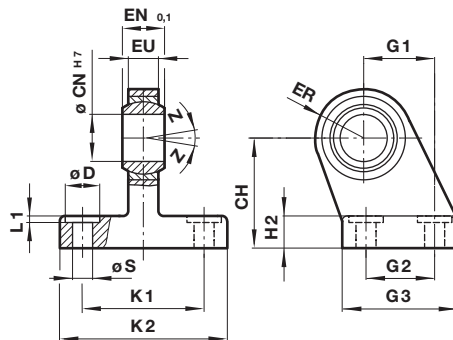

Ø	CH	Ø CN H7	Ø D	EN -0,1	ER	EU	G1	G2	G3	H2	K1	K2	L1	Ø S	Z	kg	Model (US)
32	32	10	11	14	16	10,5	21	18	31	10	38	51	1,6	6,6	13°	0,19	M/P40310
40	36	12	11	16	18	12	24	22	35	10	41	54	1,6	6,6	13°	0,24	M/P40311
50	45	16	15	21	21	15	33	30	45	12	50	65	1,6	9	13°	0,46	M/P40312
63	50	16	15	21	23	15	37	35	50	12	52	67	1,6	9	15°	0,59	M/P40313
80	63	20	18	25	28	18	47	40	60	14	66	86	2,5	11	15°	1,03	M/P40314
100	71	20	18	25	30	18	55	50	70	15	76	96	2,5	11	15°	1,40	M/P40315
80	63	20	18	25	28	18	47	40	60	14	66	86	2,5	11	15°	1,03	M/P40314
100	71	20	18	25	30	18	55	50	70	15	76	96	2,5	11	15°	1,4	M/P40315
125	90	30	20	37	40	25	70	60	90	20	94	124	3,2	14	15°	3,10	M/P71355

Assembly kit for four position cylinders

Dimensions in mm
Projection/First angle

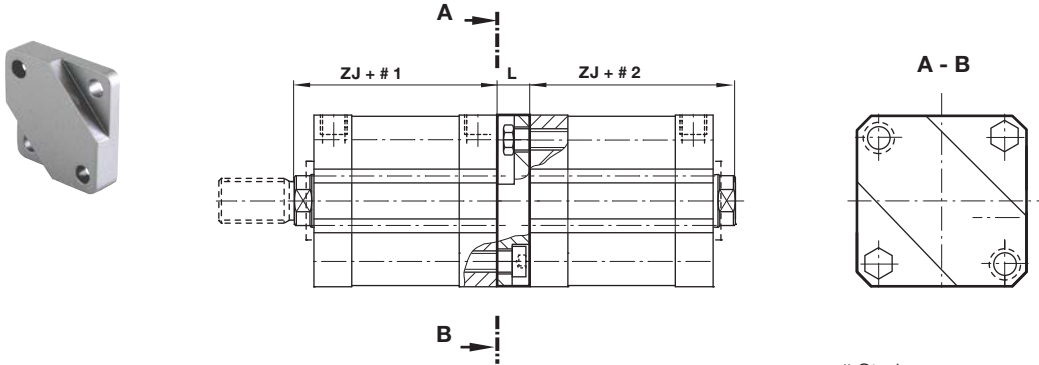

Stroke

Ø	L	ZJ	kg	Model
20	10	43	0,03	QA/192020/55
25	10	45	0,04	QA/192025/55
32	12,5	51	0,07	QA/192032/55
40	12,5	52	0,09	QA/192040/55
50	15	53	0,14	QA/192050/55
63	15	57	0,19	QA/192063/55
80	20	64	0,35	QA/192080/55
100	20	77	0,72	QA/192100/55
125	25	89	1,03	QA/192125/55

Valve mounting kit

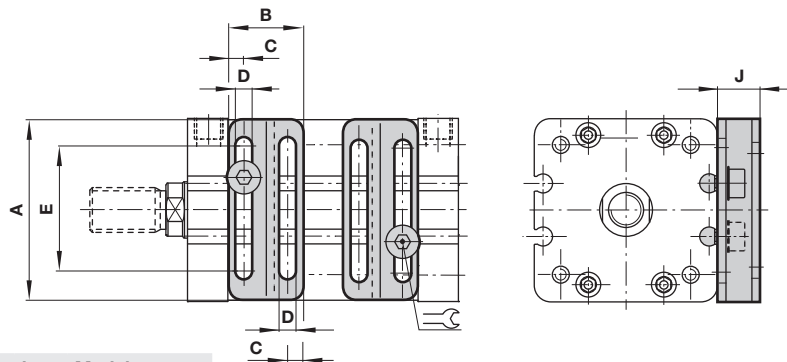

Ø	A	B	C	D	E	F	G	H	J	kg	Model	
50/63	60	37	7	4,5	46	8,5	5,5	2	12	3	0,02	QA/180050/22/54
80/100/125	90	37	7	4,5	76	8,5	6,5	2	12	3	0,02	QA/180080/22/54

Groove key

Model: M/P72816
Weight: 0,01 kg

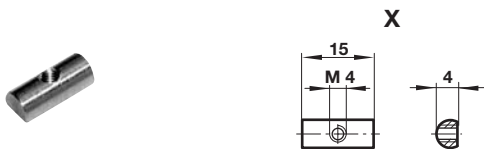

Groove cover M/P72725/1000

Model: M/P72725/1000
(length: 1m)

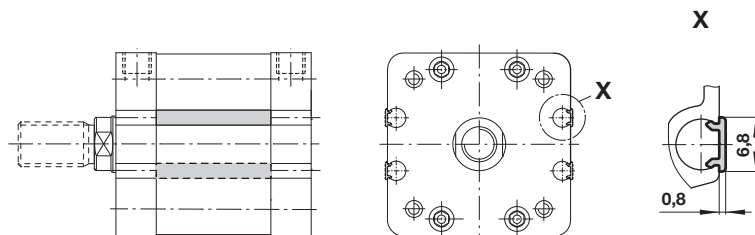

Technical data - Reed switches - additional informations see data sheet N/en 4.3.005

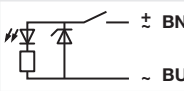
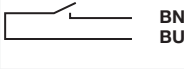
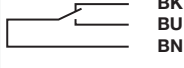
Symbol	Voltage		Current maximum (mA)	Function	Operating temperature (°C)	LED	Protection class	Plug	Cable length (m)	Cable type	Weight (g)	Model
	(V a.c.)	(V d.c.)										
	10 ... 240	10 ... 170	180	Closer	-25 ... +80	•	IP66	—	2, 5 or 10	PVC 2 x 0,25	37	M/50/LSU/*V
	10 ... 240	10 ... 170	180	Closer	-25 ... +80	•	IP66	—	5	PUR 2 x 0,25	37	M/50/LSU/5U
	10 ... 240	10 ... 170	180	Closer	-25 ... +150	—	IP66	—	2	Silicon 2 x 0,25	37	TM/50/RAU/2S
	10 ... 240	10 ... 170	180	Changeover	-25 ... +80	—	IP66	—	5	PVC 3 x 0,25	37	M/50/RAC/5V
	10 ... 240	10 ... 170	180	Changeover	-25 ... +80	—	IP66	—	5	PVC 3 x 0,25	37	M/50/RAC/5V
	10 ... 60	10 ... 60	180	Closer	-25 ... +80	•	IP66	M8 x 1	0,3	PVC 3 x 0,25	16	M/50/LSU/CP *1)

* Insert cable length; *1) Plug-in connector see page 11; Color code: BK = black, BN = brown, BU = blue

Drawings

M/50/LSU/*V, M/50/LSU/5U,
TM/50/RAU/2S
Cable length L = 2, 5 or 10 m

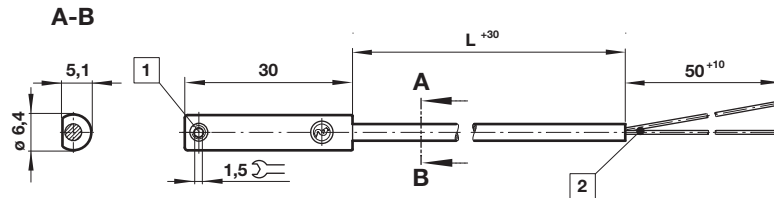

M/50/RAC/5V
Cable length L = 5 m

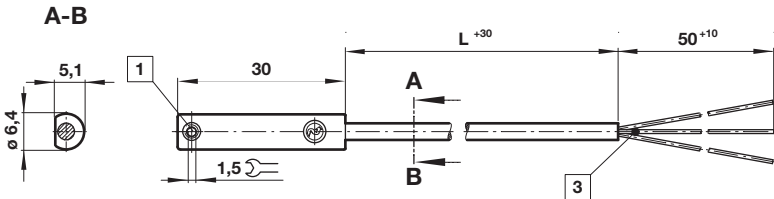

M/50/LSU/CP

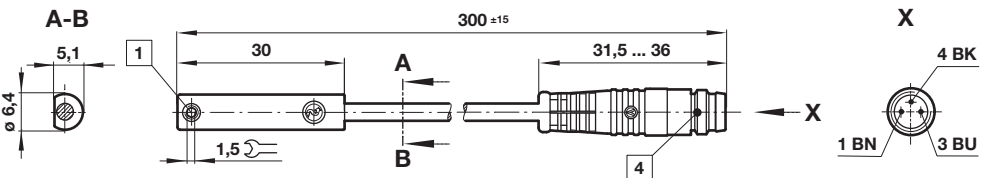

- 1 Fixing screw
- 2 + BN = brown; - BU = blue (output)
- 3 - BK = black; + BN = brown; - ≠BU = blue
- 4 Plug M8 x 1, color code: BK = black; BN = brown; BU = blue

Dimensions in mm
Projection/First angle



Accessories

Plug-in connector cable with nut



Outer cover	Cable length (m)	Weight (kg)	Connector	Connector
PVC 3 x 0,25	5 m	0,18	M8 x 1	M/P73001/5
PUR 3 x 0,25	5 m	0,18	M8 x 1	M/P73002/5
PUR 3 x 0,34	5 m	0,21	M12 x 1	M/P34594/5

Technical data - Solid state - additional informations see data sheet N/en 4.3.007

Symbol	Voltage (V d.c.)	Current maximum (mA)	Function	Operating temperature (°C)	LED	Protection class	Plug	Cable length (m)	Cable type	Weight (g)	Model
	10 ... 30	150	PNP	-40 ... +80	•	IP67	—	2, 5 or 10	PVC 3 x 0,12	37	M/50/EAP/*V
	10 ... 30	150	PNP	-40 ... +80	•	IP68	—	5	PUR 3 x 0,14	37	M/50/EAP/5U
	10 ... 30	150	PNP	-40 ... +80	•	IP67	M8 x 1	0,3	PVC 3 x 0,14	16	M/50/EAP/CP *1)
	10 ... 30	150	PNP	-40 ... +80	•	IP67	M12 x 1	0,3	PVC 3 x 0,14	16	M/50/EAP/CC *1)
	10 ... 30	150	NPN	-40 ... +80	•	IP67	—	2, 5 or 10	PVC 3 x 0,12	37	M/50/EAN/*V
	10 ... 30	150	Closer	-40 ... +80	•	IP67	M8 x 1	0,3	PVC 3 x 0,14	16	M/50/EAN/CP *1)

* Insert cable length; *1) Plug-in connector below; Color code: BK = black, BN = brown, BU = blue

Drawings

M/50/EAP/*V,
M/50/EAN/*V
Cable length L = 2, 5 or 10 m

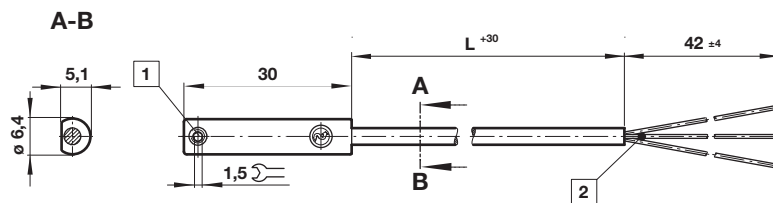

Dimensions in mm
Projection/First angle



M/50/EAP/CP,
M/50/EAN/CP

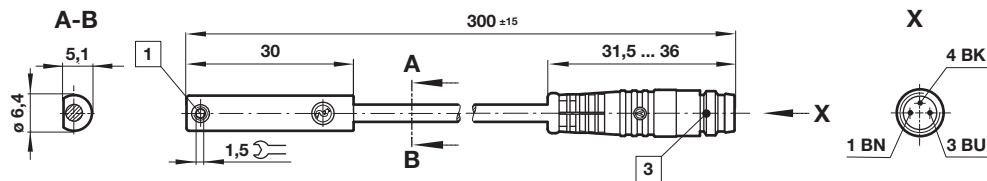

M/50/EAP/CC

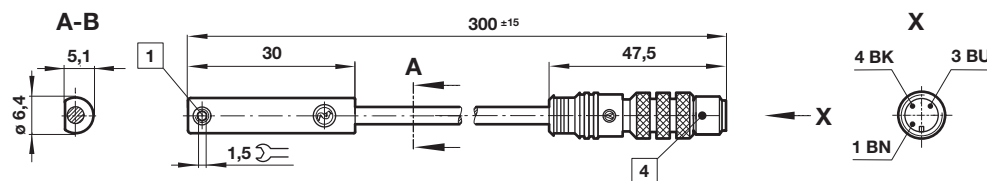

- 1 Fixing screw
- 2 Color code: BK = black; BN = brown; BU = blue
- 3 Plug M8 x 1
- 4 Plug M12 x 1

Warning

These products are intended for use in industrial compressed air systems only. Do not use these products where pressures and temperatures can exceed those listed under

»Technical features/data«.

Before using these products with fluids other than those specified, for non-industrial applications, life-support systems or other applications not within published specifications, consult IMI NORGRN.

Through misuse, age, or malfunction, components used in fluid power systems can fail in various modes.

The system designer is warned to consider the failure modes of all component parts used in fluid power systems and to provide adequate safeguards to prevent personal injury or damage to equipment in the event of such failure.

System designers must provide a warning to end users in the system instructional manual if protection against a failure mode cannot be adequately provided.

System designers and end users are cautioned to review specific warnings found in instruction sheets packed and shipped with these products.