

- > Ø 12 ... 100 mm
- > One third the basic length of a corresponding ISO/VDMA model
- > Low friction, long life seal design
- > Fully non-corrodible specification
- > Standard magnetic piston for full control system versatility



Technical features

Medium:

Compressed air, filtered, lubricated or non-lubricated

Operation:

Double acting, magnetic piston, non-cushioned

Operating pressure:

1 ... 10 bar (14 ... 145 psi)

Cylinder diameters:

12, 16, 20, 25, 32, 40, 50, 63, 80, 100 mm

Standard Strokes:

See table below

Non-standard strokes:

200 mm Ø 16 ... 25 mm
250 mm Ø 32 & 40 mm
300 mm Ø 50 ... 100 mm

Operating temperature:

-5 ... +80°C max. (+23 ... +176°F)

Air supply must be dry enough to avoid ice formation at temperatures below +2°C (+35°F).

Materials:

Barrel & end caps: Anodised aluminium alloy
Piston rod: stainless steel (Ø 12 ... 40 mm austenitic, Ø 50 ... 100 mm martensitic)
Seals: PUR and/or NBR

Technical data

Cylinder Ø (mm)	12	16	20	25	32	40	50	63	80	100
Port size	M 5	M 5	M 5	M 5	G 1/8	G 1/8	G 1/8	G 1/4	G 1/4	G 1/4
Piston rod Ø (mm)	6	8	10	12	16	16	20	20	25	25
Piston rod thread	M 3	M 4	M 5	M 6	M 8	M 8	M 10	M 12	M 16	M 16
Theoretical thrusts at 6 bar outstroke (N)	68	121	188	295	483	754	1178	1870	3016	4712
Theoretical thrusts at 6 bar instroke (N)	51	90	141	227	362	633	990	1682	2721	4418
Air consumption at 6 bar outstroke (l/cm)	0,008	0,014	0,022	0,035	0,056	0,088	0,138	0,218	0,352	0,55
Air consumption at 6 bar instroke (l/cm)	0,007	0,011	0,017	0,027	0,042	0,074	0,116	0,196	0,318	0,515

Standard strokes

Cylinder Ø (mm)	Stroke length (mm)										
	5	10	15	20	25	30	40	50	60	80	100
12	•	•	•	•	•	•	—	—	—	—	—
16	•	•	•	•	•	•	—	—	—	—	—
20	•	•	•	•	•	•	•	•	—	—	—
25	•	•	•	•	•	•	•	•	—	—	—
32	•	•	•	•	•	•	•	•	•	•	—
40	•	•	•	•	•	•	•	•	•	•	—
50	•	•	•	•	•	•	•	•	•	•	•
63	•	•	•	•	•	•	•	•	•	•	•
80	—	—	•	•	•	•	•	•	•	•	•
100	—	—	•	•	•	•	•	•	•	•	•

Cylinder variants

Symbol	Model with magnetic piston	Description	Dimensions Page
	RM/92000/M TRM/92000/M	Standard cylinder Cylinder with heat resistant seals, 150°C max. (Ø 32 ... 100 mm only)	4
	RM/92000/MU	Cylinder with extended piston rod (maximum extended piston up to 100 mm)	4
	RM/92000/JM	Cylinder with double ended piston rod Non-standard strokes available (minimal): 5 mm = Ø 16 ... 40 mm, 10 mm = Ø 50 & 100 mm	6
	RM/92000/N2	Cylinder with non-rotating piston rod (internal) Ø 16 ... 100 mm only	6
	RM/92000/N4	Cylinder with guiding, Ø 16 ... 100 mm only Non-standard strokes available (maximum): 50 mm = Ø 16 mm, 80 mm = Ø 20 & 25 mm 100 mm = Ø 32 ... 100 mm	6

Option selector

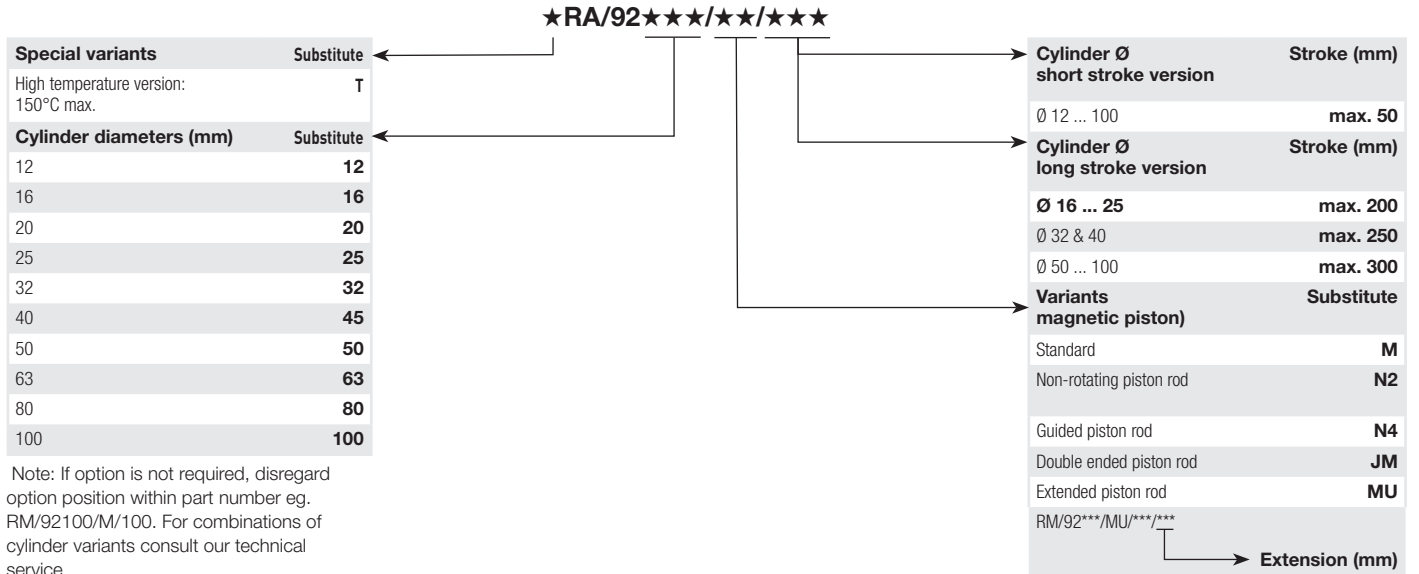





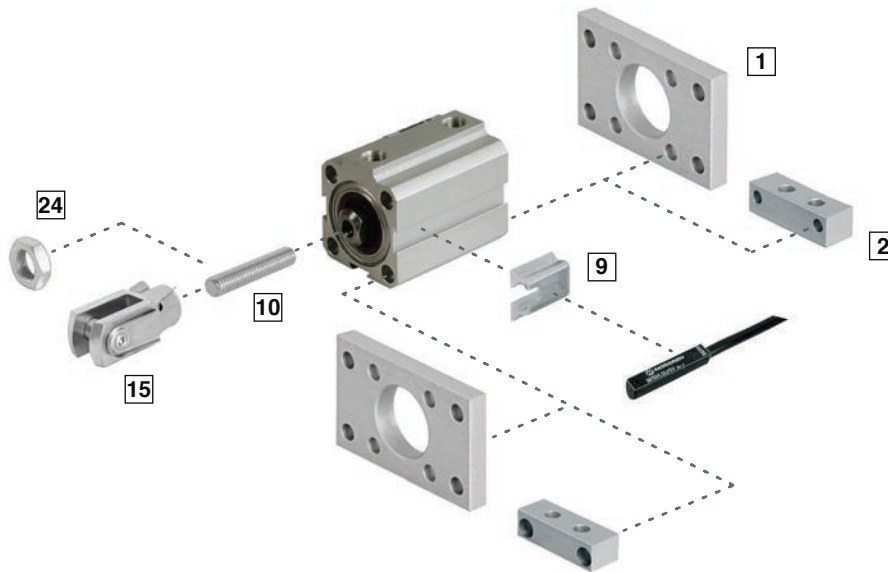

Note: If option is not required, disregard option position within part number eg. RM/92100/M/100. For combinations of cylinder variants consult our technical service.

Please note that heat resistant seals are not available for all variants. This options selector explains only the cylinder variants. Additional variants/ options can not be derived from.



Mountings



Model	B, G	C	F	N	Stud	Adaptor	Assembly kit
							
Ø	1 Page 6	2 Page 6	15 Page 6	24 Page 6	10 Page 6	10 & 24 Page 6	Page 7
12	QM/90012/22	QM/90012/21	QM/57008/25	M/P1500/111	M/P1710/18	–	QM/90012/55
16	QM/90016/22	QM/90016/21	QM/8010/25	M/P1501/80	M/P1710/19	–	QM/90016/55
20	QM/90020/22	QM/90020/21	QM/92020/25	M/P1501/109	M/P1710/20	–	QM/90020/55
25	QM/90025/22	QM/90025/21	QM/57016/25	M/P1501/79	M/P1710/21	–	QM/90025/55
32	QM/90032/22	QM/90032/21	QM/57020/25	M/P1501/60	M/P1710/22	–	QM/90032/55
40	QM/90040/22	QM/90040/21	QM/57020/25	M/P1501/60	M/P1710/22	–	QM/90040/55
50	QM/90050/22	QM/90050/21	QM/57025/25	–	–	M/P71470/1	QM/90050/55
63	QM/90063/22	QM/90063/21	QM/57040/25	–	–	M/P71470/2	QM/90063/55
80	QM/90080/22	QM/90080/21	QM/57063/25	–	–	M/P71470/3	QM/90080/55
100	QM/90100/22	QM/90100/21	QM/57063/25	–	–	M/P71470/3	QM/90100/55

* For attaching F mounting to female piston rod thread.

Accessories

Model	Magnetically operated switches	Switch mounting bracket
		
Ø	Page 8 & 9	9
All		M/P72487

RM/92000/N4 – Cylinder with guide piston rod
Permissible load and torque

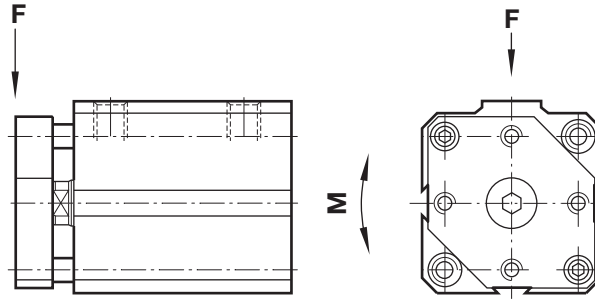

Permissible load and torque

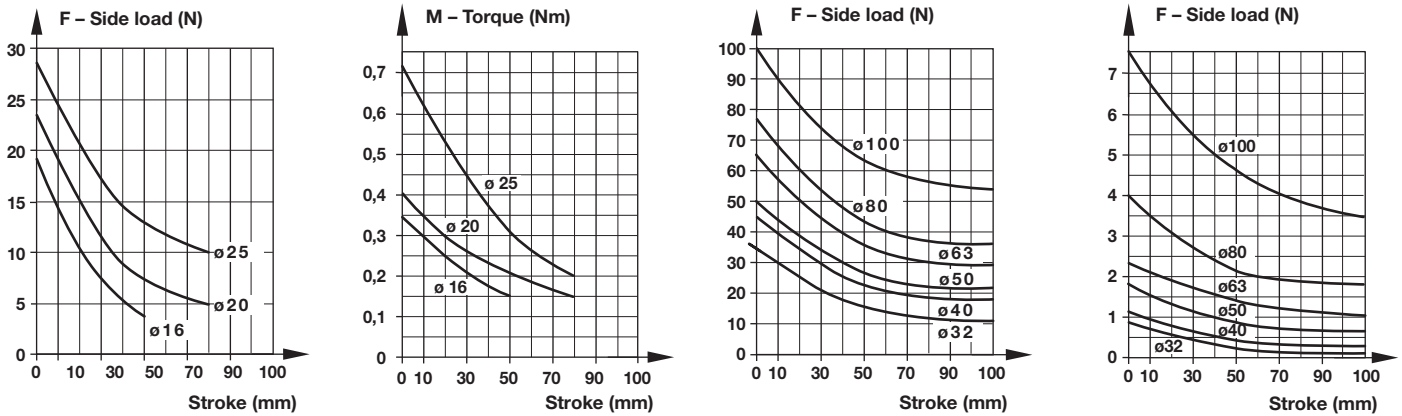

Dimensions
RM/92000/M – Standard cylinder

Dimensions in mm
Projection/First angle

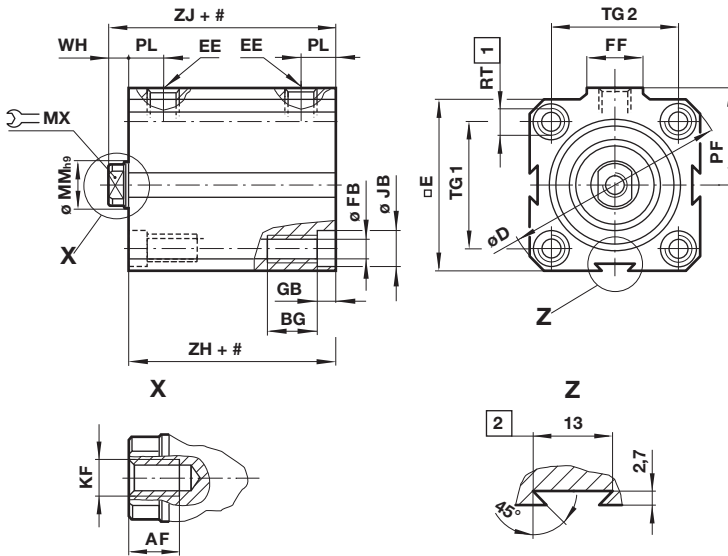

Stroke

- 1 Only the 4 front holes are tapped on stroke lengths of less than:
 Ø 25 and 32 mm: 5 mm,
 Ø 40 and 63 mm: 15 mm (.../N2: 5 mm),
 Ø 50 and 80 mm: 10 mm, Ø 100 mm: 25 mm (.../N2: 15 mm).
- 2 Note: Ø 12 to 20 mm feature only two side dovetails.

Ø	AF	BG	Ø D	□ E	EE	Ø FB	FF	GB	Ø JB	KF	Ø MM h9	MX	PF	PL	RT	TG 1 2	WH	ZH *1)	ZJ *1)	at 0 mm	per 5 mm	Model	
12	6	9	32,5	25	M 5	3,3	10	3,5	6	M 3	6	5	15	7	M 4	17	13	4,5	24	28,5	0,06 kg	0,04 kg	RM/92012/M/*
16	7	9	36,5	28	M 5	3,3	10	3,5	6	M 4	8	6	17	7,5	M 4	20	20	5,5	24,5	30	0,08 kg	0,04 kg	RM/92016/M/*
20	8	9	41,5	32	M 5	3,3	10	3,5	6	M 5	10	8	19,5	7,5	M 4	23	23	6	26	32	0,10 kg	0,06 kg	RM/92020/M/*
25	9	12	48	37	M 5	4,2	10	4,5	7,5	M 6	12	10	22	8	M 5	27	27	6,5	28,5	35	0,15 kg	0,07 kg	RM/92025/M/*
32	12	12	58	45	G1/8	4,2	18	4,5	7,5	M 8	16	13	27,5	9	M 5	33	33	6,5	29	35,5	0,25 kg	0,12 kg	RM/92032/M/*
40	12	16	71,5	55	G1/8	6,8	18	6,5	10,5	M 8	16	13	31,5	10	M 8	41	41	6,5	31,5	38	0,38 kg	0,15 kg	RM/92040/M/*
50	14	16	81	63	G1/8	6,8	18	6,5	10,5	M 10	20	17	37	10,5	M 8	48	48	8	35	43	0,45 kg	0,18 kg	RM/92050/M/*
63	16	20	104	80	G1/4	8,5	22	8,5	13,5	M 12	20	17	48	13	M 10	61	61	8	42,5	50,5	0,82 kg	0,26 kg	RM/92063/M/*
80	22	20	120	94	G1/4	8,5	22	8,5	13,5	M 16	25	22	57	14,5	M 10	73	73	9	47	56	1,20 kg	0,33 kg	RM/92080/M/*
100	22	25	148,5	116,5	G1/4	10,2	22	10,5	16,5	M 16	25	22	67	16	M 12	90,5	90,5	10	48,5	58,5	1,83 kg	0,42 kg	RM/92100/M/*

* Please insert standard stroke length.

*1) Plus s10 mm for stroke length > 50 mm

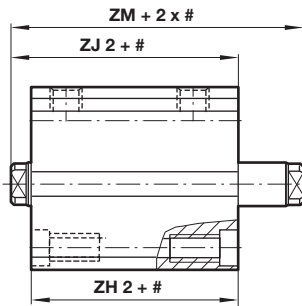
**Alternative variants
RM/92000/JM – Cylinder
with double ended piston rod**

Stroke

**RM/92000/N2 – Cylinder
with non-rotating piston rod**

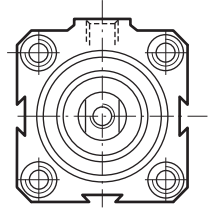
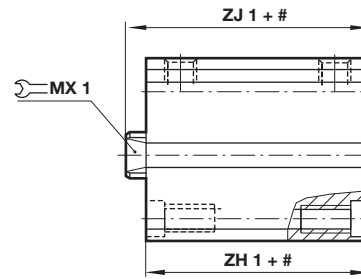
 Dimensions in mm
Projection/First angle

Stroke

Ø	ZH2	ZJ2	ZM	Model
16	29,5	35	41	RM/92016/JM/*
20	31,5	37,5	44	RM/92020/JM/*
25	34,5	41	48	RM/92025/JM/*
32	36,5	43	50	RM/92032/JM/*
40	39,5	46	53	RM/92040/JM/*
50	42	50	59	RM/92050/JM/*
63	52	60	69	RM/92063/JM/*
80	56	65	74	RM/92080/JM/*
100	58	68	78	RM/92100/JM/*

* Please insert standard stroke length.

Ø	MX1	ZH1	ZJ1	Torque max.	Model
16	6	34,5	40	0,15 Nm	RM/92016/N2/*
20	8	36	42	0,25 Nm	RM/92020/N2/*
25	10	38	45	0,4 Nm	RM/92025/N2/*
32	13	39	45,5	0,75 Nm	RM/92032/N2/*
40	13	41,5	48	0,75 Nm	RM/92040/N2/*
50	16	45	53	1,5 Nm	RM/92050/N2/*
63	16	52,5	60,5	1,5 Nm	RM/92063/N2/*
80	21	57	66	2,5 Nm	RM/92080/N2/*
100	21	58,5	68,5	2,5 Nm	RM/92100/N2/*

* Please insert standard stroke length.

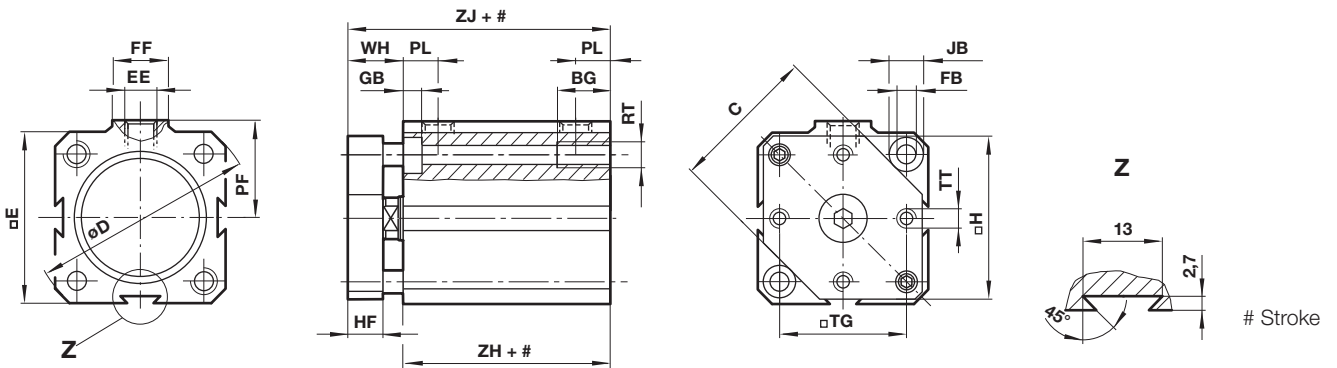
RM/92000/N4 – Cylinder with guide piston rod

Ø	BG	C	Ø D	□ E	EE	Ø FB	FF	GB	□ H	HF	Ø JB	PF	PL	RT	□ TG	TT	WH	ZH *1)	ZJ *1)	at 0 mm	per 5 mm	Model
16	9	21	36,5	28	M 5	3,3	10	3,5	26,5	6	6	17	7,5	M 4	20	M 3	11,5	24,5	36	0,110 kg	0,050 kg	RM/92016/N4/*
20	9	25	41,5	32	M 5	3,3	10	3,5	30	8	6	19,5	7,5	M 4	23	M 3	14	26	40	0,130 kg	0,070 kg	RM/92020/N4/*
25	12	29,5	48	37	M 5	4,2	10	4,5	35	8	7,5	22	8	M 5	27	M 4	14,5	28,5	43	0,170 kg	0,100 kg	RM/92025/N4/*
32	12	38	58	45	G 1/8	4,2	18	4,5	43	10	7,5	27,5	9	M 5	33	M 4	16,5	29	45,5	0,280 kg	0,130 kg	RM/92032/N4/*
40	16	46,5	71,5	55	G 1/8	6,8	18	6,5	52	10	10,5	31,5	10	M 8	41	M 5	16,5	31,5	48	0,440 kg	0,150 kg	RM/92040/N4/*
50	16	56,5	81	63	G 1/8	6,8	18	6,5	60	12	10,5	37	10,5	M 8	48	M 6	20	35	55	0,500 kg	0,200 kg	RM/92050/N4/*
63	20	71	104	80	G 1/4	8,5	22	8,5	76	12	13,5	48	13	M 10	61	M 8	20	42,5	62,5	0,900 kg	0,300 kg	RM/92063/N4/*
80	20	89	120	94	G 1/4	8,5	22	8,5	90	16	13,5	57	14,5	M 10	73	M 10	25	47	72	1,350 kg	0,350 kg	RM/92080/N4/*
100	25	110	148,5	116,5	G 1/4	10,2	22	10,5	113	20	16,5	67	16	M 12	90,5	M 13	30	48,5	78,5	2,200 kg	0,600 kg	RM/92100/N4/*

* Please insert standard stroke length.

*1) Plus 10 mm for stroke length > 50 mm

Mountings
Front or rear flange B, G

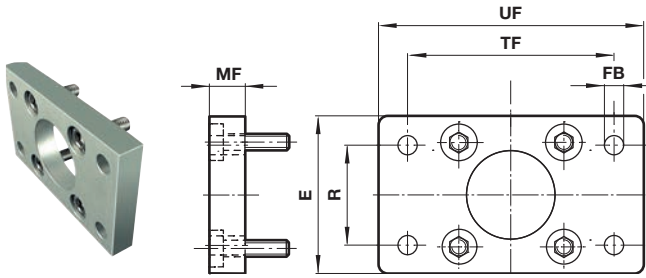

Ø	E	R	Ø FB	MF	TF	UF	kg	Model (B,G)
12	26	18	3,5	5	38	46	0,02	QM/90012/22
16	30	22	3,5	5	42	50	0,02	QM/90016/22
20	33	25	3,5	5	48	56	0,02	QM/90020/22
25	38	28	4,5	6,5	54	64	0,04	QM/90025/22
32	46	36	4,5	6,5	66	76	0,06	QM/90032/22
40	57	43	6,5	9,5	78	92	0,15	QM/90040/22
50	64	50	6,5	9,5	90	104	0,17	QM/90050/22
63	81	63	9,5	12,5	110	128	0,33	QM/90063/22
80	95	77	8,5	12,5	128	146	0,41	QM/90080/22
100	118	98	11	12,5	156	176	0,72	QM/90100/22

Foot C, ISO 6432

Dimensions in mm
Projection/First angle

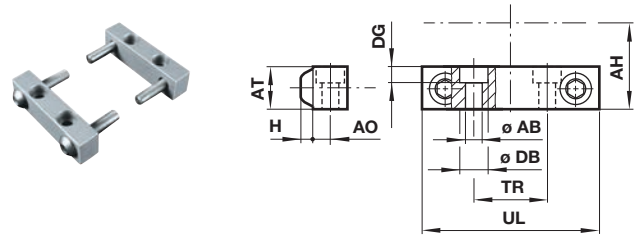

Ø	Ø AB	AH	AO	AT	H	Ø DB	DG	TR	UL	kg	Model (C)
12	3,4	13,5	4	9,5	2	6	3,5	25	33	0,02	QM/90012/21
16	3,4	15	4	9,5	2	6	3,5	32	40	0,02	QM/90016/21
20	3,4	16,5	4	9,5	2	6	3,5	35	43	0,02	QM/90020/21
25	4,3	20	5	12,5	3	7,5	4,5	41	51	0,04	QM/90025/21
32	4,3	23	5	12,5	3	7,5	4,5	19	46	0,04	QM/90032/21
40	6,4	28,5	6,5	16	4,5	10,5	6,5	21	56	0,1	QM/90040/21
50	6,4	32	6,5	16	4,5	10,5	6,5	27	64	0,11	QM/90050/21
63	8,4	41,5	8	22	5,5	13,5	8,5	34	81	0,13	QM/90063/21
80	8,4	49	8	25,5	5,5	13,5	8,5	44	95	0,18	QM/90080/21
100	10,5	59,5	9	28,5	6,5	16,5	10,5	56	118	0,48	QM/90100/21

Piston rod clevis – F

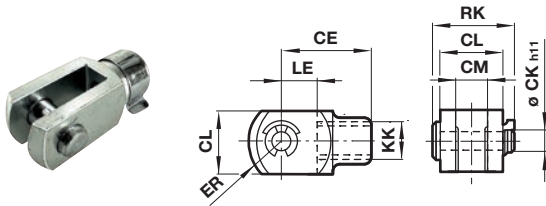

Ø	KK	CE	Ø CK h11	CL	CM	ER	LE	RK	kg	Model
12	M3	11	3 h9	6	3	4,5	5	10	0,01	QM/57008/25
16	M4	16	4	8	4	6,5	8	11,5	0,01	QM/8010/25
20	M5	20	5	10	5	8	10	14,5	0,01	QM/92020/25
25	M6	20	5	10	5	8	10	14,5	0,01	QM/57016/25
32 & 40	M8	24	6	12	6	9,5	12	17,5	0,02	QM/57020/25
50	M10x1,25	26	8	14	7	11,5	12	20,5	0,04	QM/57025/25
63	M12x1,25	40	10	20	11	16	20	29	0,09	QM/57040/25
80 & 100	M16x1,5	56	14	27	14	21	28	36,5	0,22	QM/57063/25

Stud



Ø	A	KF	kg	Model
12	12	M3	0,01	MP/1710/18
16	16	M4	0,01	MP/1710/19
20	20	M5	0,01	MP/1710/20
25	25	M6	0,01	MP/1710/21
32 & 40	25	M8	0,01	MP/1710/22

Nose nut N

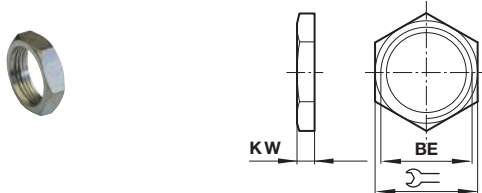

Ø	BE	KW		kg	Model
12	M3	2	6	0,01	MP/1500/111
16	M4	2	7	0,01	MP/1501/80
20	M5	2,5	8	0,01	MP/1501/109
25	M6	3	10	0,01	MP/1501/79
32 & 40	M8	4	13	0,01	MP/1501/60

Adaptor

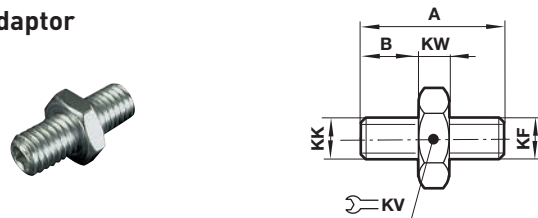

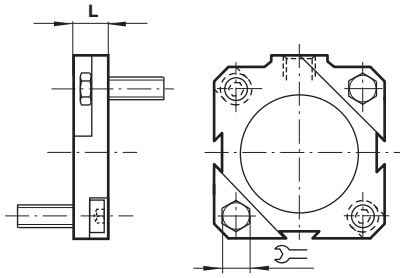

Ø	A	B	KF	KK		KV	KW	kg	Model
50	29	12	M10	M10x1,25	12	5	0,02	MP/71470/1	
63	35	15	M12	M12x1,25	13	5	0,04	MP/71470/2	
80 & 100	45	20	M16	M16x1,5	17	5	0,08	MP/71470/3	

Assembly kit

 Dimensions in mm
 Projection/First angle

\varnothing	L		Type
12	10	7	QM/90012/55
16	10	7	QM/90016/55
20	10	7	QM/90020/55
25	10	8	QM/90025/55
32	10	8	QM/90032/55
40	15	13	QM/90040/55
50	15	13	QM/90050/55
63	20	17	QM/90063/55
80	20	17	QM/90080/55
100	25	19	QM/90100/55

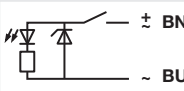
Technical data - Reed switches - additional informations see data sheet N/en 4.3.005

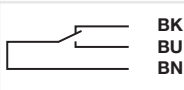
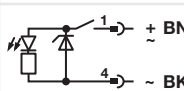
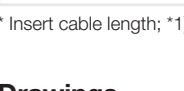
Symbol	Voltage		Current maximum (mA)	Function	Operating temperature (°C)	LED	Protection class	Plug	Cable length (m)	Cable type	Weight (g)	Model
	(V a.c.)	(V d.c.)										
	10 ... 240	10 ... 170	180	Closer	-25 ... +80	•	IP66	—	2, 5 or 10	PVC 2 x 0,25	37	M/50/LSU/*V
	10 ... 240	10 ... 170										
	10 ... 240	10 ... 170	180	Closer	-25 ... +80	•	IP66	—	5	PUR 2 x 0,25	37	M/50/LSU/5U
	10 ... 240	10 ... 170										
	10 ... 240	10 ... 170	180	Closer	-25 ... +150	—	IP66	—	2	Silicon 2 x 0,25	37	TM/50/RAU/2S
	10 ... 240	10 ... 170	180	Changeover	-25 ... +80	—	IP66	—	5	PVC 3 x 0,25	37	M/50/RAC/5V
	10 ... 60	10 ... 60	180	Closer	-25 ... +80	•	IP66	M8 x 1	0,3	PVC 3 x 0,25	16	M/50/LSU/CP *1)

* Insert cable length; *1) Plug-in connector see page 11; Color code: BK = black, BN = brown, BU = blue

Drawings

M/50/LSU/*V, M/50/LSU/5U,
TM/50/RAU/2S
Cable length L = 2, 5 or 10 m

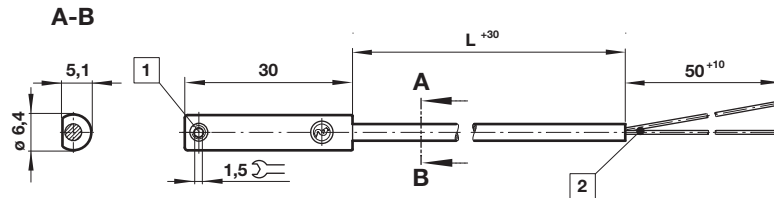

Dimensions in mm
Projection/First angle



M/50/RAC/5V
Cable length L = 5 m

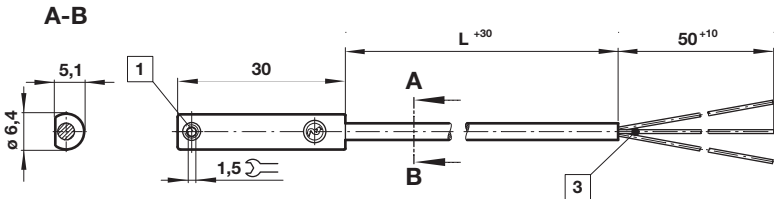

M/50/LSU/CP

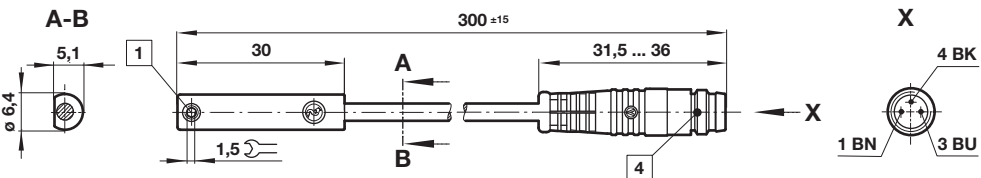

- 1 Fixing screw
- 2 + BN = brown; - BU = blue (output)
- 3 - BK = black; + BN = brown; - ≠BU = blue
- 4 Plug M8 x 1, color code: BK = black; BN = brown; BU = blue

Accessories

Switch mounting bracket



M/P72487

Plug-in connector cable with nut



Outer cover	Cable length (m)	Weight (kg)	Connector	Connector
PVC 3 x 0,25	5 m	0,18	M8 x 1	M/P73001/5
PUR 3 x 0,25	5 m	0,18	M8 x 1	M/P73002/5
PUR 3 x 0,34	5 m	0,21	M12 x 1	M/P34594/5

Technical data - Solid state - additional informations see data sheet N/en 4.3.007

Symbol	Voltage (V d.c.)	Current maximum (mA)	Function	Operating temperature (°C)	LED	Protection class	Plug	Cable length (m)	Cable type	Weight (g)	Model
	10 ... 30	150	PNP	-40 ... +80	•	IP67	—	2, 5 or 10	PVC 3 x 0,12	37	M/50/EAP/*V
	10 ... 30	150	PNP	-40 ... +80	•	IP68	—	5	PUR 3 x 0,14	37	M/50/EAP/5U
	10 ... 30	150	PNP	-40 ... +80	•	IP67	M8 x 1	0,3	PVC 3 x 0,14	16	M/50/EAP/CP *1)
	10 ... 30	150	PNP	-40 ... +80	•	IP67	M12 x 1	0,3	PVC 3 x 0,14	16	M/50/EAP/CC *1)
	10 ... 30	150	NPN	-40 ... +80	•	IP67	—	2, 5 or 10	PVC 3 x 0,12	37	M/50/EAN/*V
	10 ... 30	150	Closer	-40 ... +80	•	IP67	M8 x 1	0,3	PVC 3 x 0,14	16	M/50/EAN/CP *1)

* Insert cable length; *1) Plug-in connector below; Color code: BK = black, BN = brown, BU = blue

Drawings

M/50/EAP/*V,
M/50/EAN/*V
Cable length L = 2, 5 or 10 m

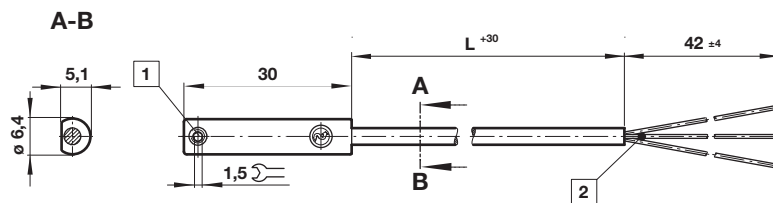

Dimensions in mm
Projection/First angle



M/50/EAP/CP,
M/50/EAN/CP

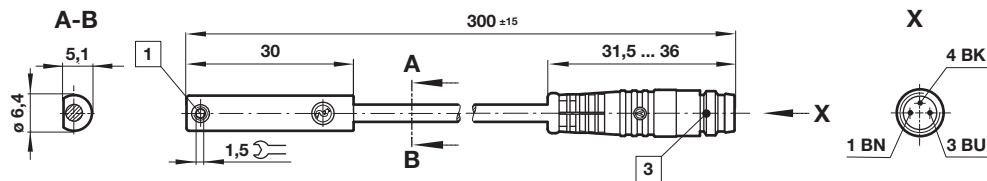

M/50/EAP/CC

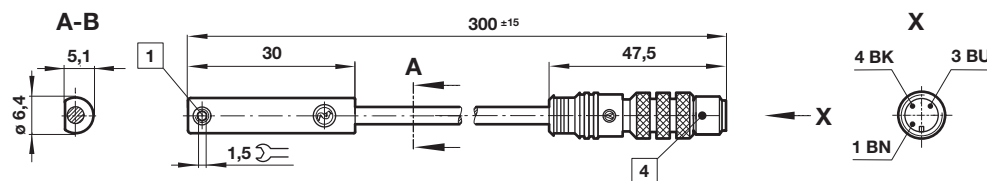

- 1 Fixing screw
- 2 Color code: BK = black; BN = brown; BU = blue
- 3 Plug M8 x 1
- 4 Plug M12 x 1

Warning

These products are intended for use in industrial compressed air systems only. Do not use these products where pressures and temperatures can exceed those listed under

»Technical features/data«.

Before using these products with fluids other than those specified, for non-industrial applications, life-support systems or other applications not within published specifications, consult IMI NORGRN.

Through misuse, age, or malfunction, components used in fluid power systems can fail in various modes.

The system designer is warned to consider the failure modes of all component parts used in fluid power systems and to provide adequate safeguards to prevent personal injury or damage to equipment in the event of such failure.

System designers must provide a warning to end users in the system instructional manual if protection against a failure mode cannot be adequately provided.

System designers and end users are cautioned to review specific warnings found in instruction sheets packed and shipped with these products.