

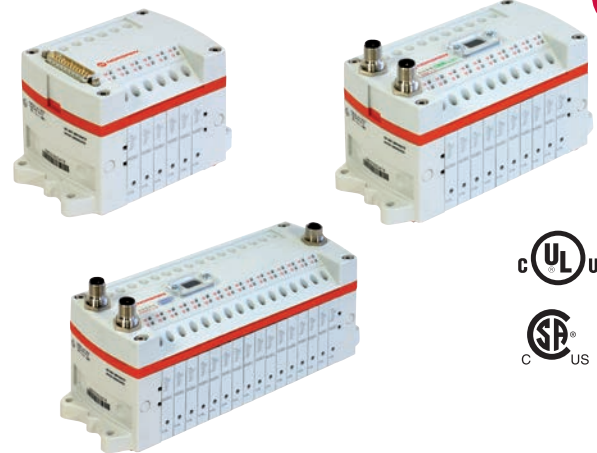

- > Valve slices 2 x 3/2, 5/2 and 5/3 with integral push-in fittings Ø 3, 4, 6 mm
- > Multipole or individually wired for installation flexibility
- > Interchangeable Fieldbus modules
- > Fieldbus options available - Profibus-DP, DeviceNet and CANopen
- > Compact and lightweight
- > Quick disconnect base (Pneumapole)
- > High flow from 10 mm valve width
- > Flexible design concept
- > To configure and order a Valve Island visit - vi.norgren.com



Technical features

Medium:
Compressed air, filtered, lubricated and non-lubricated

Operation:
Spool valve indirectly actuated

Port sizes:
Ø 3 , 4, 6 mm Push-in fittings
Imperial versions also available

Operating pressure:
Details see page 2

Flow:

Function	l/min	Cv	Kv
5/2 ports			
1 » 2 & 4	430	0,44	0,36
5/2 ports			
2 » 3 & 4 » 5	400	0,41	0,34
3/2 and 5/3	350	0,36	0,29

Insulation protection:
Individually wired: IP40
Multipole & Fieldbus: IP65

Ambient/Media temperature:
-5 ... +50°C (+23 ... +122 °F)
Air supply must be dry enough to avoid ice formation at temperatures below +2°C (+35°F).

Materials:
Body, end plates: engineered PPA co-polymer
Spool: aluminium
Seals: NBR

Protection classification

UL/CSA approval
Recognized to UL 429 - 5th edition & CSA 22.2 No.139 - 1982 for Electrically Operated Valves.

ATEX
The 24 V d.c. multipole and fieldbus valve islands fulfil the requirement of the standard EN60079-0:2012 and EN60079-15:2010 for intended use in explosive atmospheres.

For Ex applications conforming to Zone 2 category ATEX 3G (gases):
II3G Ex nA IIc T5 Gc
Zone 22 category ATEX 3D (dusts):
II3D Ex tc IIc T90°C Dc -5°C
< Ta > +50°C

Please review all ATEX data and notes in the installation and maintenance instruction manual to ensure correct and safe installation of the valve island.

Technical data

2 x 3/2 Double solenoid actuated valves

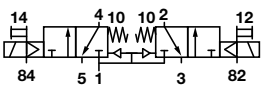
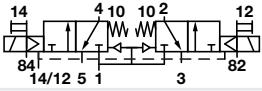
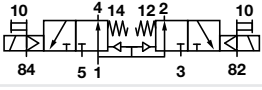
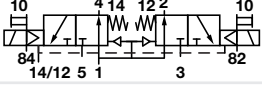
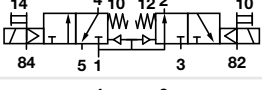
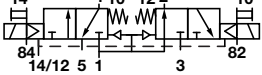
Symbol	Function	Actuation	Pilot supply	Manual override	Operating pressure (bar)	Operating pressure (psi)	Pilot pressure (bar)	Pilot pressure (psi)	Weight (kg)	Model
	2 x 3/2 NC	Solenoid/Spring	Internal	Turn & lock	3 ... 8	43 ... 116	—	—	0,054	VM10*A11AB213B
	2 x 3/2 NC	Solenoid/Spring	Internal	Push only	3 ... 8	43 ... 116	—	—	0,054	VM10*A11AB313B
	2 x 3/2 NC	Solenoid/Spring	External	Turn & lock	-0,9 ... 8	-13 ... 116	3 ... 8	43 ... 116	0,054	VM10*A22AB213B
	2 x 3/2 NC	Solenoid/Spring	External	Push only	-0,9 ... 8	-13 ... 116	3 ... 8	43 ... 116	0,054	VM10*A22AB313B
	2 x 3/2 NO	Solenoid/Spring	Internal	Turn & lock	3 ... 8	43 ... 116	—	—	0,054	VM10*B11AB213B
	2 x 3/2 NO	Solenoid/Spring	Internal	Push only	3 ... 8	43 ... 116	—	—	0,054	VM10*B11AB313B
	2 x 3/2 NO	Solenoid/Spring	External	Turn & lock	-0,9 ... 8	-13 ... 116	3 ... 8	43 ... 116	0,054	VM10*B22AB213B
	2 x 3/2 NO	Solenoid/Spring	External	Push only	-0,9 ... 8	-13 ... 116	3 ... 8	43 ... 116	0,054	VM10*B22AB313B
	2 x 3/2 NO/NC	Solenoid/Spring	Internal	Turn & lock	3 ... 8	43 ... 116	—	—	0,054	VM10*C11AB213B
	2 x 3/2 NO/NC	Solenoid/Spring	Internal	Push only	3 ... 8	43 ... 116	—	—	0,054	VM10*C11AB313B
	2 x 3/2 NO/NC	Solenoid/Spring	External	Turn & lock	-0,9 ... 8	-13 ... 116	3 ... 8	43 ... 116	0,054	VM10*C22AB213B
	2 x 3/2 NO/NC	Solenoid/Spring	External	Push only	-0,9 ... 8	-13 ... 116	3 ... 8	43 ... 116	0,054	VM10*C22AB313B

5/2 Single and double solenoid actuated valves

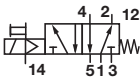
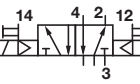
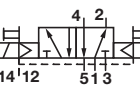
Symbol	Function	Actuation	Pilot supply	Manual override	Operating pressure (bar)	Operating pressure (psi)	Pilot pressure (bar)	Pilot pressure (psi)	Weight (kg)	Model
	5/2	Solenoid/Spring	Internal	Turn & lock	3 ... 8	43 ... 116	—	—	0,044	VM10*517AB213B
	5/2	Solenoid/Spring	Internal	Push only	3 ... 8	43 ... 116	—	—	0,044	VM10*517AB313B
	5/2	Solenoid/Spring	External	Turn & lock	-0,9 ... 8	-13 ... 116	3 ... 8	43 ... 116	0,044	VM10*527AB213B
	5/2	Solenoid/Spring	External	Push only	-0,9 ... 8	-13 ... 116	3 ... 8	43 ... 116	0,044	VM10*527AB313B
	5/2	Solenoid/Solenoid	Internal	Turn & lock	2 ... 8	29 ... 116	—	—	0,054	VM10*511AB213B
	5/2	Solenoid/Solenoid	Internal	Push only	2 ... 8	29 ... 116	—	—	0,054	VM10*511AB313B
	5/2	Solenoid/Solenoid	External	Turn & lock	-0,9 ... 8	-13 ... 116	2 ... 8	29 ... 116	0,054	VM10*522AB213B
	5/2	Solenoid/Solenoid	External	Push only	-0,9 ... 8	-13 ... 116	2 ... 8	29 ... 116	0,054	VM10*522AB313B

5/3 Double solenoid actuated valves

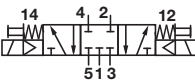
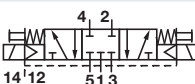
Symbol	Function	Actuation	Pilot supply	Manual override	Operating pressure (bar)	Operating pressure (psi)	Pilot pressure (bar)	Pilot pressure (psi)	Weight (kg)	Model
	5/3 APB	Solenoid/Solenoid	Internal	Turn & lock	3 ... 8	43 ... 116	—	—	0,055	VM10*611AB213B
	5/3 APB	Solenoid/Solenoid	Internal	Push only	3 ... 8	43 ... 116	—	—	0,055	VM10*611AB313B
	5/3 APB	Solenoid/Solenoid	External	Turn & lock	-0,9 ... 8	-13 ... 116	3 ... 8	43 ... 116	0,055	VM10*622AB213B
	5/3 APB	Solenoid/Solenoid	External	Push only	-0,9 ... 8	-13 ... 116	3 ... 8	43 ... 116	0,055	VM10*622AB313B

* For selection of port sizes please see page 3

Note: For 5/3 COE please use 2 x 3/2 NC. For 5/3 COP please use 2 x 3/2 NO

APB = All Ports Blocked COE = Centre Open Exhaust COP = Centre Open Pressure

Electrical details

Voltage:	24 V d.c. 0,6 W*
Surge suppression:	Flywheel diode
Indication:	Yellow LED

* 12 V d.c. also available.

Please consult our Technical Service.

Solenoids

Voltage tolerance:	± 10%
Rating:	100% ED

Option selector
VM10***AB*13B**

Tube size	Substitute
3 mm PIF	3
4 mm PIF	4
6 mm PIF	6
No PIF (for use with Pneumapole) *1)	7
Valve function	Substitute
5/2	5
5/3 APB	6
2 x 3/2 NC and 5/3 COE	A
2 x 3/2 NO and 5/3 COP	B
2 x 3/2 NC and NO	C

Manual override	Substitute
Turn to lock manual override	2
Push only manual override	3
Actuation/pilot supply	Substitute
Solenoid/solenoid internal pilot	11
Solenoid/spring internal pilot *2)	17
Solenoid/solenoid external pilot	22
Solenoid/spring external pilot *2)	27

To order a complete valve island please use the configurator at; vi.norgren.com

Note:

For 5/3 COE and COP use

2 x 3/2 APB = All Ports Blocked

COE = Centre Open Exhaust



COP = Centre Open Pressure

For valve island specification see page 16 and 17





*1) Requires Pneumapole sub-base

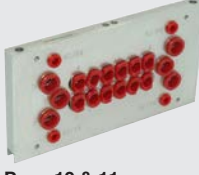



*2) Can only be used with 5/2 valve

Accessories







Valve blanking station	Port blanking station	Pneumapole sub-base
		
Page 6	Page 6	Page 10 & 11
VM106517AQ0300	VM106517AQ0301 (Port 1 blanked) VM106517AQ0302 (Ports 3 & 5 blanked) VM106517AQ0303 (Ports 1, 3 & 5 blanked)	Details see page

DIN Rail fixing kit	DIN rail	Label cover kit	Labels
			
V11900-C01, 8D	V10009-C00 (1 m)	V12016-K36 (4 Station) V12016-K37 (6 Station) V12016-K38 (8 Station)	V12016-K39 (10 Station) V12016-K40 (12 Station) V12016-K41 (16 Station)
		V12033-L02 (write and seal label) V12034-L02 (paper label)	

Pressure switch for pilot ports 12 and 14	Silencer	Plug	Manual override kit Push only	Rotate by hand, lockable
				
Page 15	Page 15	Page 15	V11574-K30	V11574-K31
VM106517AQ0804 (4 mm) VM106517AQ0806 (6 mm)	T45P0006 (6 mm) T45P0008 (8 mm) T45P0010 (10 mm) T45P0012 (12 mm)	C00040600 (6 mm) C00040800 (8 mm) C00041000 (10 mm) C00041200 (12 mm)		

D Sub-connector 25 pin, IP65	D Sub-connector 44 pin, IP65	D Sub-connector 25 pin 90°, IP65	D Sub-connector 44 pin 90°, IP65	2 Pin connector IP40
				
Page 13	Page 13	Page 14	Page 14	
V11569-E01 (1 m) — L1 V11569-E03 (3 m) — L2 V11569-E05 (5 m) — L3	V11570-E01 (1 m) — M1 V11570-E03 (3 m) — M1 V11570-E05 (5 m) — M1	V12086-E01 (1 m) — L4 V12086-E03 (3 m) — L5 V12086-E05 (5 m) — L6	V12088-E01 (1 m) — M4 V12088-E03 (3 m) — M5 V12088-E05 (5 m) — M6	V11556-E10 (1 m) — K2 V11556-E03 (0,3 m) — K1

Fieldbus accessories

	Description	Connection	Cable length	Short code	Model
	Fieldbus power connector DeviceNet (4 pin, female) CANopen (4 pin, female) Profibus-DP (4 pin, female)	M12	Wireable	R1	V11588-E01
	DeviceNet (5 pin, female) CANopen (5 pin, female)	M12	Wireable	R2	V11589-E01
	Profibus-DP, reverse keyway (5 pin, female)	M12	Wireable	R3	V11590-E01
	Profibus-DP, reverse keyway (5 pin male)	M12	Wireable	R4	V11591-E01
	Profibus-DP connector (9 pin, male with terminating resistor)	D-Sub IP40	Wireable	R0	V11654-E01
	Profibus - DP terminating resistor	M12	-	R6	V11592-E01

Dimensions

Single solenoid

Double solenoid

5/3 APB, double solenoid

Blanking plates

Dimensions in mm
Projection/First angle

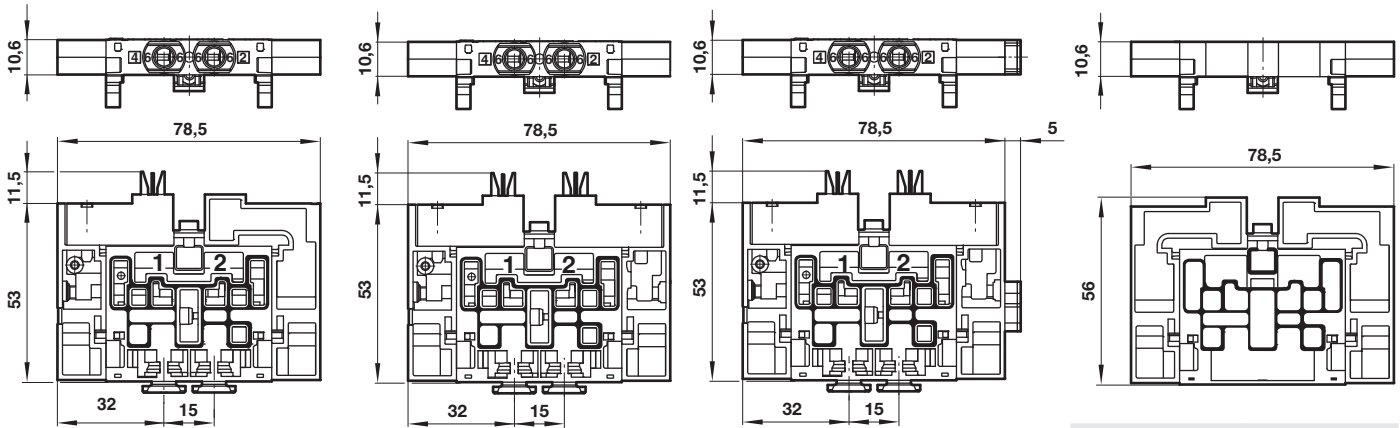

Port connections

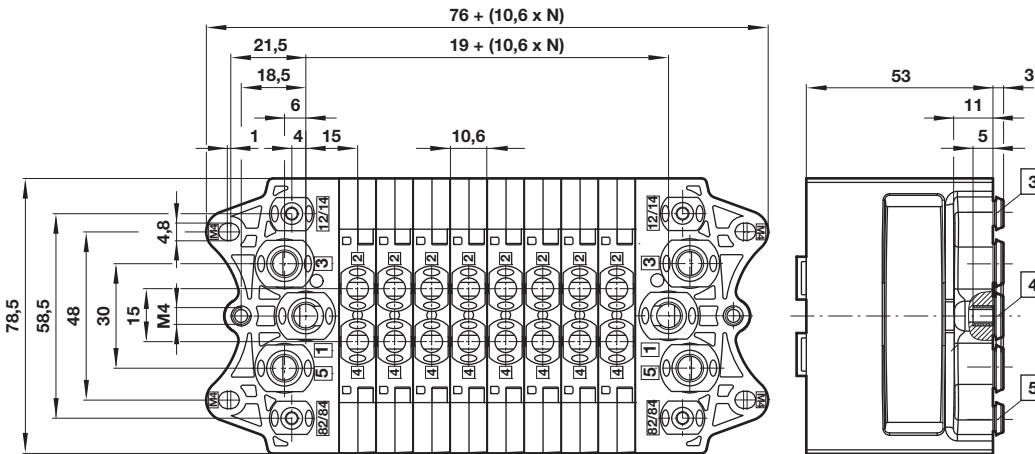

Blanking plates	Short code	Weight (kg)
VM106517AQ0300	B000	0,028
VM106517AQ0301, port 1 blanked	B100	0,028
VM106517AQ0302, ports 3 & 5 blanked	B300	0,028
VM106517AQ0303, ports 1, 3 & 5 blanked	B500	0,028

3 Ports 12/14
4 Ports 1, 3 & 5
5 Ports 82/84
 N = number of stations
 Detailed CAD drawings available at: cad.norgren.com

Description	Ports 1, 3 & 5 Tube outside Ø	Ports 12/14 & 82/84 Tube outside Ø	Ports 2 & 4 Tube outside Ø	Short code	Weight (kg)	Model
End plate kit - feed both ends	10	6	6	F100	0,170	VM106517AQ010Y
End plate kit - feed both ends	8	4	4	F800	0,170	VM106517AQ0108
End plate kit - feed left, right blocked	10	6	6	L100	0,170	VM106517AQ011Y
End plate kit - feed left, right blocked	8	4	4	L800	0,170	VM106517AQ0118
End plate kit - feed right, left blocked	10	6	6	R100	0,170	VM106517AQ012Y
End plate kit - feed right, left blocked	8	4	4	R800	0,170	VM106517AQ0128
End plate kit - feed both ends - Pneumapole	no PIF 1)	no PIF 1)	no PIF *1)	FPZ0	0,170	VM106517AQ0131
End plate kit - feed left, right blocked - Pneumapole	no PIF 1)	no PIF 1)	no PIF *1)	RPZ0	0,170	VM106517AQ0132
End plate kit - feed right, left blocked - Pneumapole	no PIF 1)	no PIF 1)	no PIF *1)	LPZ0	0,170	VM106517AQ0133

Available valve port sizes – Ø 3 mm, 4 mm and 6 mm; *1) No push in fitting for use with pneumapole sub-base

Panel cut-out detail

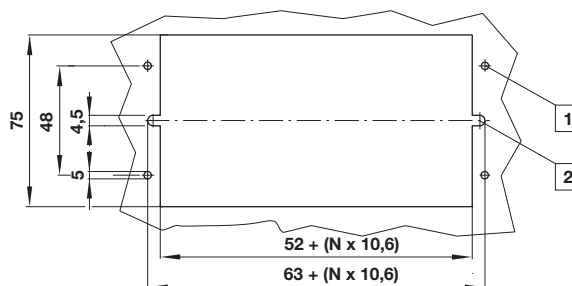

1 For mounting island from outside of panel using M4 threads in valve island end plates
2 For using through-mounting holes in valve island end plates

**Modular assembly
Individually wired IP40**

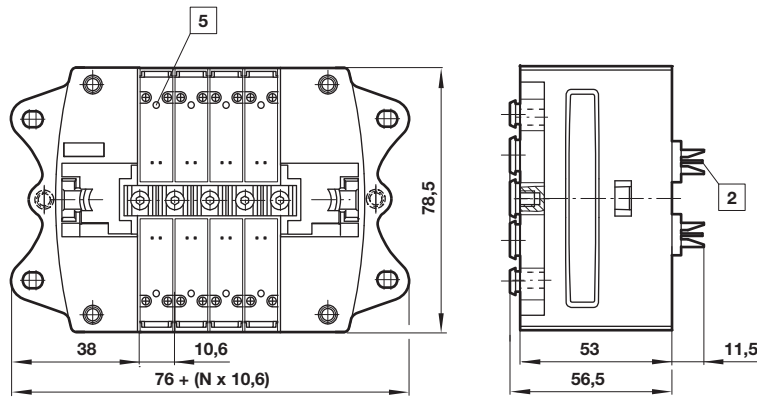
 Dimensions in mm
Projection/First angle

- 2 2 pin connector interface
- 5 Manual override
- N = number of stations

Individually wired	No. of stations	Max. no. of coils	Weight (kg)*
2 pin connector	2 ... 20	40	0,170

* kg + valves weight

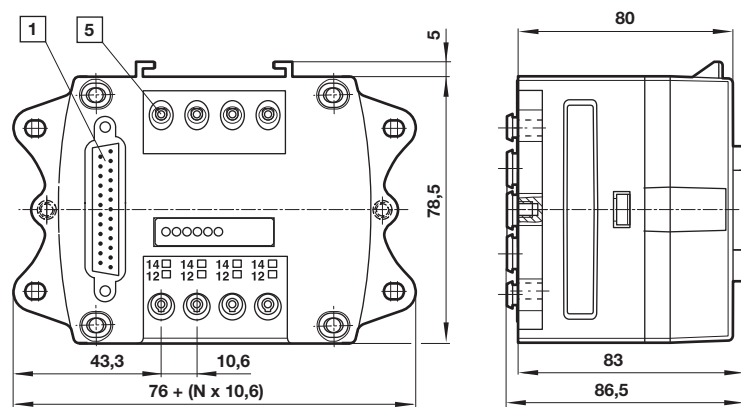
Multipole IP65

- 1 25 Pin connector for 4, 6, 8, 10 & 12 station
- 5 44 Pin connector for 12 & 16 station
- Manual override, actuate with screw driver
- N = number of stations

Multipole	No. of stations	-ve common Model	Short code	+ve common Model	Short code	Max. no. of coils	Weight (kg)
25 Pin connector	4	VM106517AQ0404	2N04	VM106517RQ0404	2P04	8	0,116
25 Pin connector	6	VM106517AQ0406	2N06	VM106517RQ0406	2P06	12	0,122
25 Pin connector	8	VM106517AQ0408	2N08	VM106517RQ0408	2P08	16	0,128
25 Pin connector	10	VM106517AQ0410	2N10	VM106517RQ0410	2P10	20	0,134
25 Pin connector	12	VM106517AQ0412	2N12	VM106517RQ0412	2P12	24	0,140
44 Pin connector	12	VM106517AQ0512	4N12	VM106517RQ0512	4P12	24	0,144
44 Pin connector	16	VM106517AQ0516	4N16	VM106517RQ0516	4P16	32	0,160

Fieldbus connections (M12 connector types IP65)

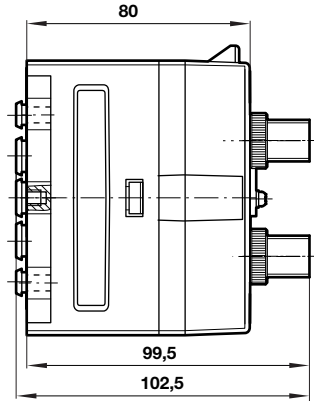
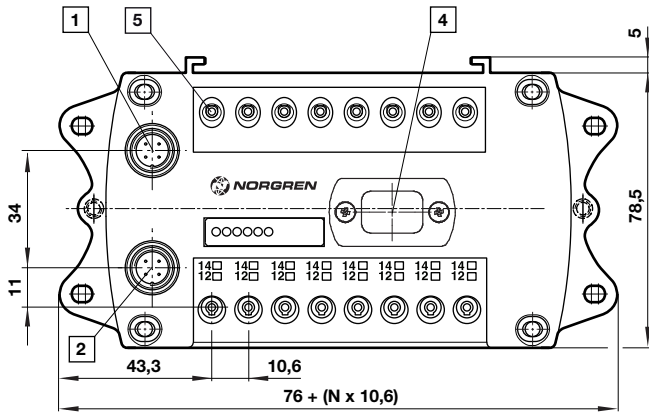

DeviceNet.
CANopen

Dimensions in mm
Projection/First angle



- 1 M12 power connector
- 2 M12 protocol connector
- 4 Rotary address switch
- 5 Manual override, actuate with screw driver
N = number of stations

Standard fieldbus	No. of stations	Max. no. of coils	Short code	Weight (kg)	Model
DeviceNet	08	16	DR08	0,138	VM10DNFNB00082
DeviceNet	10	20	DR10	0,144	VM10DNFNB00102
DeviceNet	12	24	DR12	0,150	VM10DNFNB00122
DeviceNet	16	32	DR16	0,170	VM10DNFNB00162
CANopen	08	16	CR08	0,138	VM10CAFNB00082
CANopen	10	20	CR10	0,144	VM10CAFNB00102
CANopen	12	24	CR12	0,150	VM10CAFNB00122
CANopen	16	32	CR16	0,170	VM10CAFNB00162

Connector details

Power connection, male

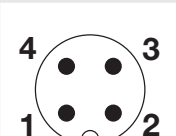
	Pin no.	Function	Tolerance	Max. current
	1	24 VB Logic circuit supply	±30%	300 mA
	2	24 VA Valves	±10%	1,5 A
	3	0 V	-	,53 A
	4	Ear h	-	-

Viewed from above

DeviceNet & CANopen

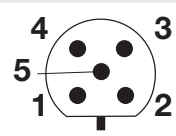
	Pin no.	Function
	1	Drain
	2	V+
	3	V-
	4	CAN_H
	5	CAN_L2

Fieldbus connections (M12 connector types IP65)

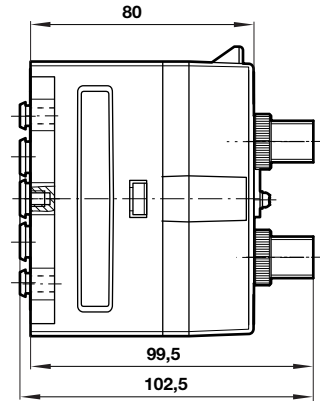
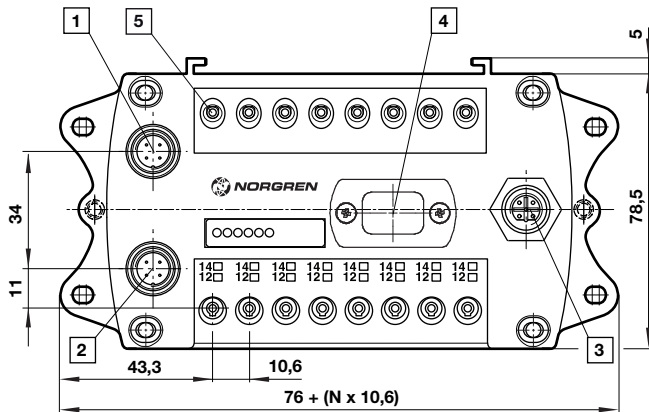

Dimensions in mm
Projection/First angle



- 1 M12 power connector
 - 2 M12 protocol connector (male)
 - 3 M12 protocol connector (female)
 - 4 Rotary address switch
 - 5 Manual override, actuate with screw driver
- N = number of stations

Standard fieldbus	No. of stations	Max. no. of coils	Short code	Weight (kg)	Model
Profibus-DP	08	16	PS08	0,138	VM10DPFNB00082
Profibus-DP	10	20	PS10	0,144	VM10DPFNB00102
Profibus-DP	12	24	PS12	0,150	VM10DPFNB00122
Profibus-DP	16	32	PS16	0,170	VM10DPFNB00162

Connector details
Power connection, male

	Pin no.	Function	Tolerance	Max. current
	1	24 VB Logic circuit supply	±30%	300 mA
	2	24 VA Valves	±10%	1,5 A
	3	0 V	-	1,53 A
	4	Earth	-	-

Viewed from above

Profibus-DP

Male Communication in	Female Communication out	Pin no.	Function
		1	5 VI Opto isolator
		2	A-line (green)
		3	0 VI Opto isolated
		4	B-line (red)
		5	Shield

Pneumapole sub-base – bottom ported

Dimensions in mm
Projection/First angle

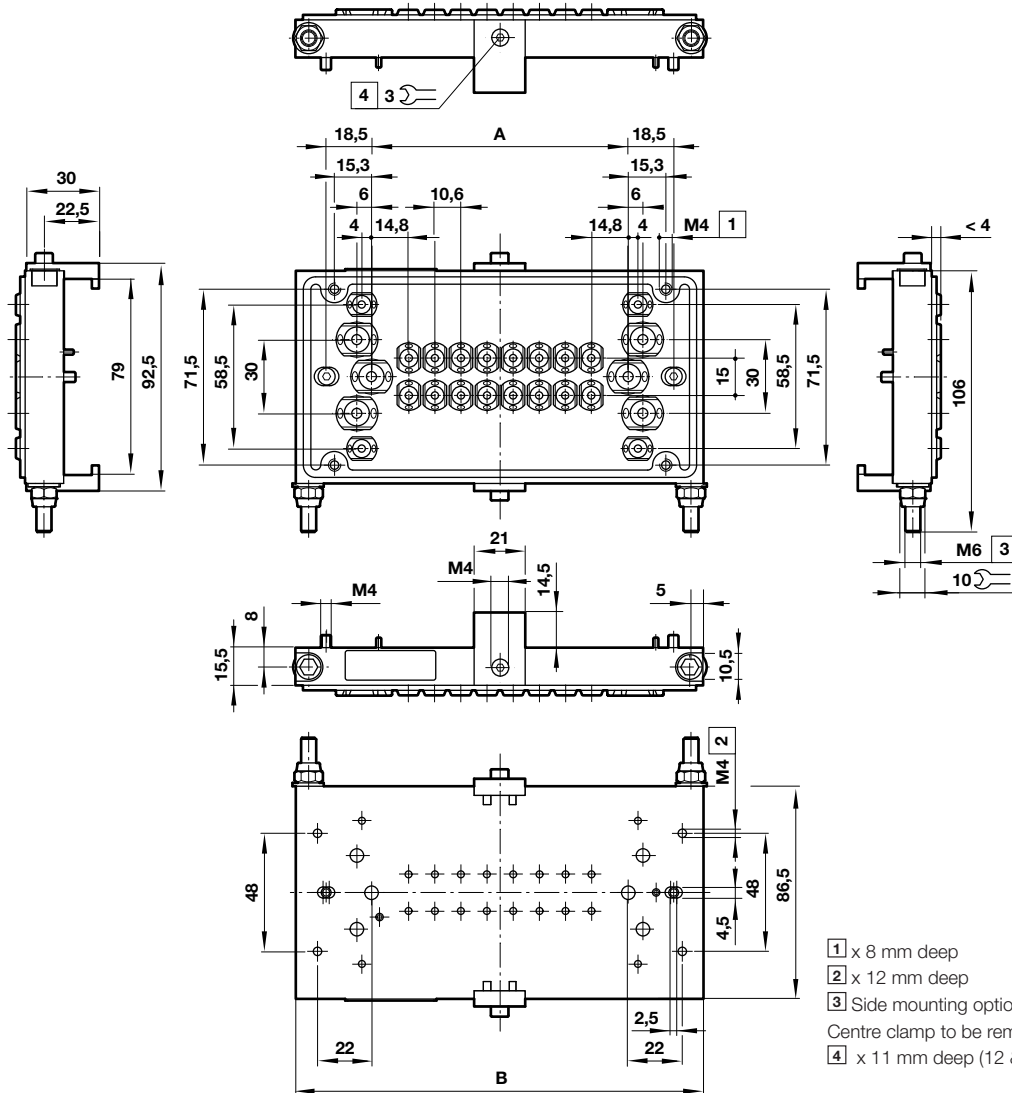

- 1 x 8 mm deep
- 2 x 12 mm deep
- 3 Side mounting option.
- Centre clamp to be removed if utilised.
- 4 x 11 mm deep (12 & 16 station version only)

Description	Ports 1, 3 & 5	Ports 12/14 & 82/84	Ports 2 & 4	Short code	Model
4 station Pneumapole	10 mm	6 mm	6 mm	6B04	VM106517AQ6604
6 station Pneumapole	10 mm	6 mm	6 mm	6B06	VM106517AQ6606
8 station Pneumapole	10 mm	6 mm	6 mm	6B08	VM106517AQ6608
10 station Pneumapole	10 mm	6 mm	6 mm	6B10	VM106517AQ6610
12 station Pneumapole	10 mm	6 mm	6 mm	6B12	VM106517AQ6612
16 station Pneumapole	10 mm	6 mm	6 mm	6B16	VM106517AQ6616

No. of stations	A	B
4	61,5	123,5
6	82,5	144,5
8	104	165,5
10	125	186,5
12	146,5	207,5
16	189	249,5

Note: Ports 82/84 (solenoid pilot exhausts) should not be plugged. A filter or silencer can be fitted or the air can be piped away with tubing.

Panel cut-out detail

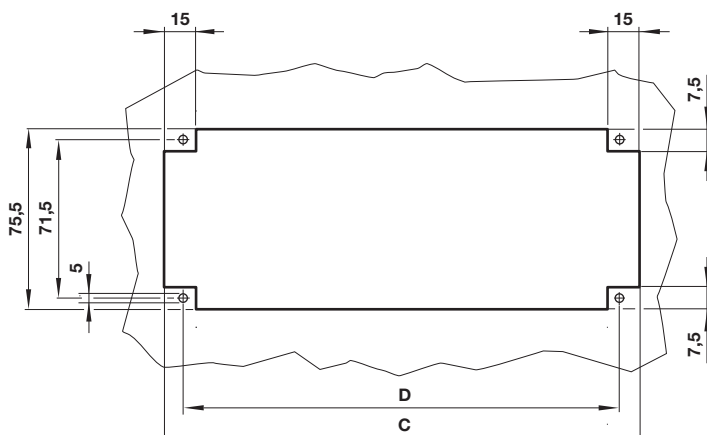

No. of stations	C	D
4	111	92
6	132	113,5
8	153	134,5
10	174	155,5
12	195	177
16	237	219,5

Pneumapole sub-base – side ported

Dimensions in mm
Projection/First angle

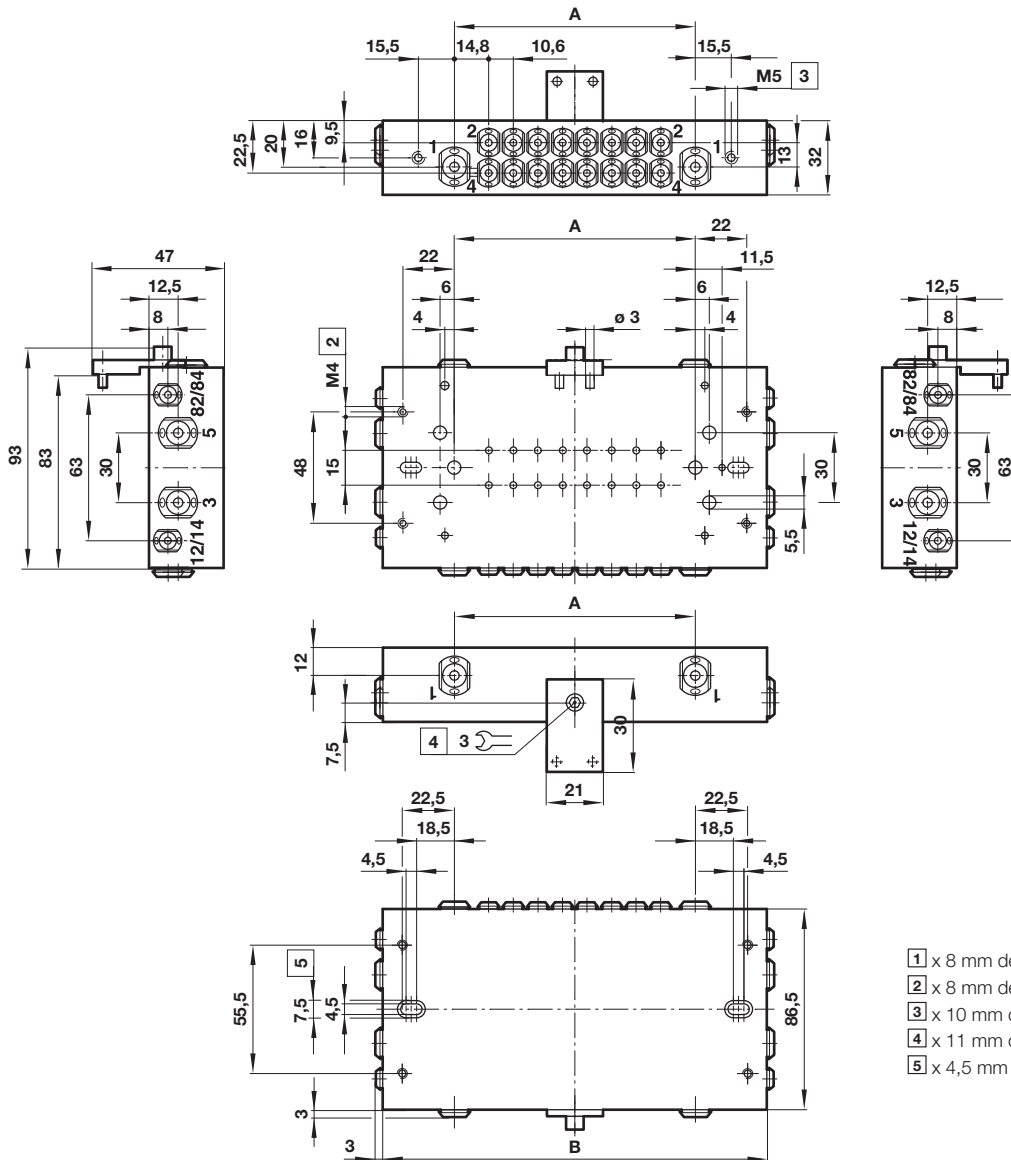

- 1 x 8 mm deep
- 2 x 8 mm deep
- 3 x 10 mm deep
- 4 x 11 mm deep (12 & 16 station version only)
- 5 x 4,5 mm deep

Description	Port 1	Ports 3 & 5	Ports 12/14 & 82/84	Ports 2 & 4	Short code	Model
4 station Pneumapole	10 mm	8 mm	6 mm	6 mm	6S04	VM106517AQ6S04
6 station Pneumapole	10 mm	8 mm	6 mm	6 mm	6S06	VM106517AQ6S06
8 station Pneumapole	10 mm	8 mm	6 mm	6 mm	6S08	VM106517AQ6S08
10 station Pneumapole	10 mm	8 mm	6 mm	6 mm	6S10	VM106517AQ6S10
12 station Pneumapole	10 mm	8 mm	6 mm	6 mm	6S12	VM106517AQ6S12
16 station pneumapole	10 mm	8 mm	6 mm	6 mm	6S16	VM106517AQ6S16

No. of stations	A	B
4	61,5	123,5
6	82,5	144,5
8	104	165,5
10	125	186,5
12	146,5	207,5
16	189	249,5

Note: Ports 82/84 (solenoid pilot exhausts) should not be plugged. A filter or silencer can be fitted or the air can be piped away with tubing.

Panel cut-out detail

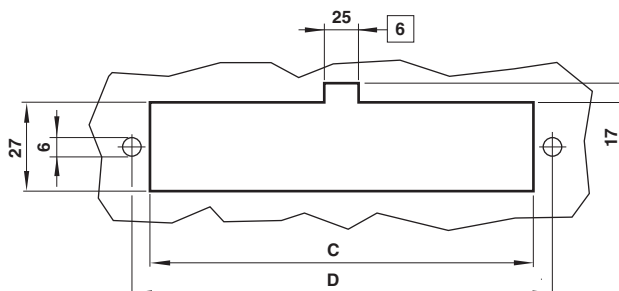

No. of stations	C	D
4	80	92,5
6	101	113,5
8	122	135
10	143	156
12	164	177,5
16	206	220

6 Additional cut-out required when rear mounting 12 & 16 station versions

Multi-pressure options

Single pressure

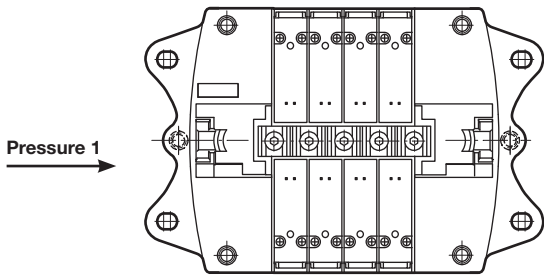

Two pressure

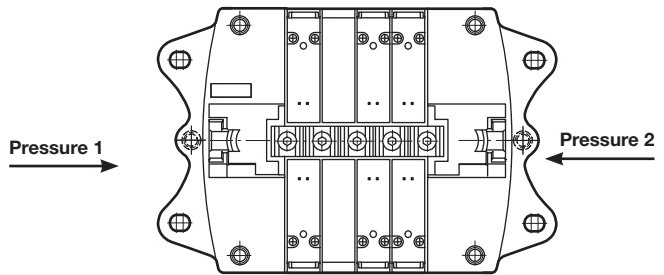

Dimensions in mm
Projection/First angle



Blanking slice
gallery 1
VM106517AQ0301

Three pressure

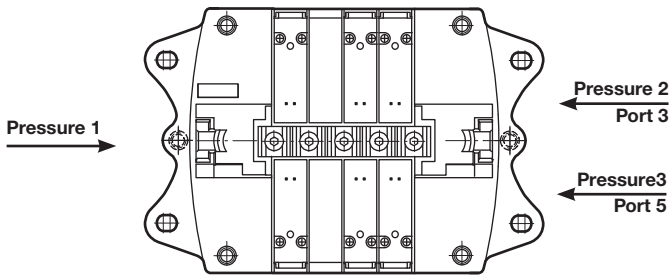

Blanking slice
galleries 1, 3 & 5
VM106517AQ0303

Four pressure

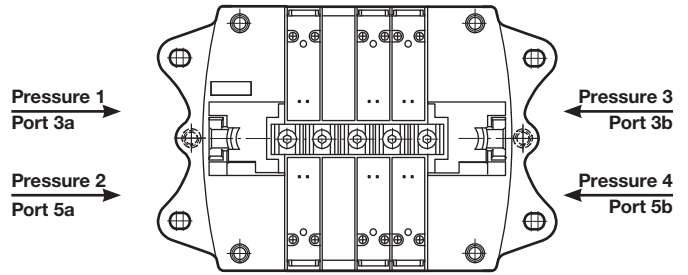

Blanking slice
galleries 3 & 5
VM106517AQ0302

3 & 4 Pressure islands are achieved by using externally piloted 2x3/2 valves and reverse porting via ports 3 & 5, Please note that when 2x3/2 valves are reverse ported the functions are also reversed i.e. N/C becomes N/O and N/O becomes N/C

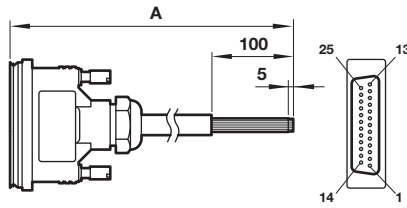
**D sub-connector 25 pin
(IP65)**

A	Model
1 m	V11569-E01
3 m	V11569-E03
5 m	V11569-E05

Pin no.	Wire colour	Socket	Pilot	Station
1	White	Solenoid 1-a	14	1
2	Brown	Solenoid 2-a	14	2
3	Green	Solenoid 3-a	14	3
4	Yellow	Solenoid 4-a	14	4
5	Grey	Solenoid 5-a	14	5
6	Pink	Solenoid 6-a	14	6
7	Blue	Solenoid 7-a	14	7
8	Red	Solenoid 8-a	14	8
9	Black	Solenoid 9-a	14	9
10	Violet	Solenoid 10-a	14	10
11	Grey/Pink	Solenoid 11-a	14	11
12	Red/Blue	Solenoid 12-a	14	12
13	White/Green	Common-Ve		—
14	Brown/Green	Solenoid 1-b	12	1
15	White/Yellow	Solenoid 2-b	12	2
16	Yellow/Brown	Solenoid 3-b	12	3
17	White/Grey	Solenoid 4-b	12	4
18	Grey/Brown	Solenoid 5-b	12	5
19	White/Pink	Solenoid 6-b	12	6
20	Pink/Brown	Solenoid 7-b	12	7
21	White/Blue	Solenoid 8-b	12	8
22	Brown/Blue	Solenoid 9-b	12	9
23	White/Red	Solenoid 10-b	12	10
24	Brown/Red	Solenoid 11-b	12	11
25	White/Black	Solenoid 12-b	12	12

Note: Conforms to DIN 47100

**D Sub-connector 44 pin
(IP65)**

Dimensions in mm
Projection/First angle

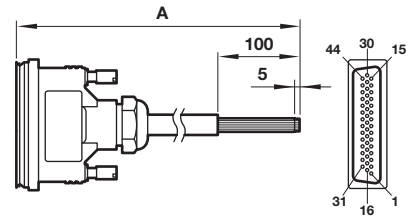

A	Model
1 m	V11570-E01
3 m	V11570-E03
5 m	V11570-E05

Pin no.	Wire colour	Socket	Pilot	Station
1	White	Solenoid 1-a	14	1
2	Brown	Solenoid 2-a	14	2
3	Green	Solenoid 3-a	14	3
4	Yellow	Solenoid 4-a	14	4
5	Grey	Solenoid 5-a	14	5
6	Pink	Solenoid 6-a	14	6
7	Blue	Solenoid 7-a	14	7
8	Red	Solenoid 8-a	14	8
9	Black	Solenoid 9-a	14	9
10	Violet	Solenoid 10-a	14	10
11	Grey/Pink	Solenoid 11-a	14	11
12	Red/Blue	Solenoid 12-a	14	12
13	White/Green	Solenoid 13-a	14	13
14	Brown/Green	Solenoid 14-a	14	14
15	White/Yellow	Solenoid 15-a	14	15
16	Yellow/Brown	Solenoid 1-b	12	1
17	White/Grey	Solenoid 2-b	12	2
18	Grey/Brown	Solenoid 3-b	12	3
19	White/Pink	Solenoid 4-b	12	4
20	Pink/Brown	Solenoid 5-b	12	5
21	White/Blue	Solenoid 6-b	12	6
22	Brown/Blue	Solenoid 7-b	12	7
23	White/Red	Solenoid 8-b	12	8
24	Brown/Red	Solenoid 9-b	12	9
25	White/Black	Solenoid 10-b	12	10
26	Brown/Black	Solenoid 11-b	12	11
27	Grey/Green	Solenoid 12-b	12	12
28	Yellow/Grey	Solenoid 13-b	12	13
29	Pink/Green	Solenoid 14-b	12	14
30	Yellow/Pink	Solenoid 15-b	12	15
31	Green/Blue	Solenoid 16-a	14	16
32	Yellow/Blue	Solenoid 16-b	12	16
33	—	Not used	—	—
34	—	Not used	—	—
35	—	Not used	—	—
36	—	Not used	—	—
37	—	Not used	—	—
38	—	Not used	—	—
39	—	Not used	—	—
40	—	Not used	—	—
41	—	Not used	—	—
42	—	Not used	—	—
43	—	Not used	—	—
44	Red/Black Yellow/Black	Common -Ve	—	—

D Sub-connector 25 pin 90° (IP65)

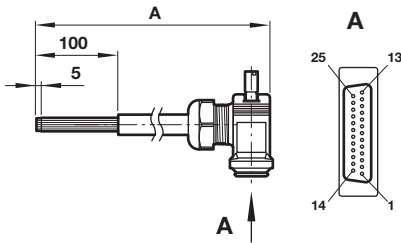

A	Model
1 m	V12086-E01
3 m	V12086-E03
5 m	V12086-E05

D Sub-connector 44 pin 90° (IP65)

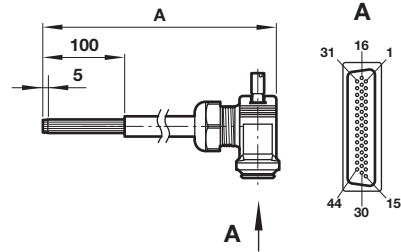

A	Model
1m	V12088-E01
3m	V12088-E03
5m	V12088-E05

Dimensions in mm
Projection/First angle



Pin no.	Wire colour	Socket	Pilot	Station
1	White	Solenoid 1-a	14	1
2	Brown	Solenoid 2-a	14	2
3	Green	Solenoid 3-a	14	3
4	Yellow	Solenoid 4-a	14	4
5	Grey	Solenoid 5-a	14	5
6	Pink	Solenoid 6-a	14	6
7	Blue	Solenoid 7-a	14	7
8	Red	Solenoid 8-a	14	8
9	Black	Solenoid 9-a	14	9
10	Violet	Solenoid 10-a	14	10
11	Grey/Pink	Solenoid 11-a	14	11
12	Red/Blue	Solenoid 12-a	14	12
13	White/Green	Common-Ve		-
14	Brown/Green	Solenoid 1-b	12	1
15	White/Yellow	Solenoid 2-b	12	2
16	Yellow/Brown	Solenoid 3-b	12	3
17	White/Grey	Solenoid 4-b	12	4
18	Grey/Brown	Solenoid 5-b	12	5
19	White/Pink	Solenoid 6-b	12	6
20	Pink/Brown	Solenoid 7-b	12	7
21	White/Blue	Solenoid 8-b	12	8
22	Brown/Blue	Solenoid 9-b	12	9
23	White/Red	Solenoid 10-b	12	10
24	Brown/Red	Solenoid 11-b	12	11
25	White/Black	Solenoid 12-b	12	12

Note: Conforms to DIN 47100e

Pin no.	Wire colour	Socket	Pilot	Station
1	White	Solenoid 1-a	14	1
2	Brown	Solenoid 2-a	14	2
3	Green	Solenoid 3-a	14	3
4	Yellow	Solenoid 4-a	14	4
5	Grey	Solenoid 5-a	14	5
6	Pink	Solenoid 6-a	14	6
7	Blue	Solenoid 7-a	14	7
8	Red	Solenoid 8-a	14	8
9	Black	Solenoid 9-a	14	9
10	Violet	Solenoid 10-a	14	10
11	Grey/Pink	Solenoid 11-a	14	11
12	Red/Blue	Solenoid 12-a	14	12
13	White/Green	Solenoid 13-a	14	13
14	Brown/Green	Solenoid 14-a	14	14
15	White/Yellow	Solenoid 15-a	14	15
16	Yellow/Brown	Solenoid 1-b	12	1
17	White/Grey	Solenoid 2-b	12	2
18	Grey/Brown	Solenoid 3-b	12	3
19	White/Pink	Solenoid 4-b	12	4
20	Pink/Brown	Solenoid 5-b	12	5
21	White/Blue	Solenoid 6-b	12	6
22	Brown/Blue	Solenoid 7-b	12	7
23	White/Red	Solenoid 8-b	12	8
24	Brown/Red	Solenoid 9-b	12	9
25	White/Black	Solenoid 10-b	12	10
26	Brown/Black	Solenoid 11-b	12	11
27	Grey/Green	Solenoid 12-b	12	12
28	Yellow/Grey	Solenoid 13-b	12	13
29	Pink/Green	Solenoid 14-b	12	14
30	Yellow/Pink	Solenoid 15-b	12	15
31	Green/Blue	Solenoid 16-a	14	16
32	Yellow/Blue	Solenoid 16-b	12	16
33	—	Not used	—	—
34	—	Not used	—	—
35	—	Not used	—	—
36	—	Not used	—	—
37	—	Not used	—	—
38	—	Not used	—	—
39	—	Not used	—	—
40	—	Not used	—	—
41	—	Not used	—	—
42	—	Not used	—	—
43	—	Not used	—	—
44	Red/Black Yellow/Black	Common -Ve	—	—

**Pressure switch for
pilot ports 12 & 14**

 Dimensions in mm
Projection/First angle

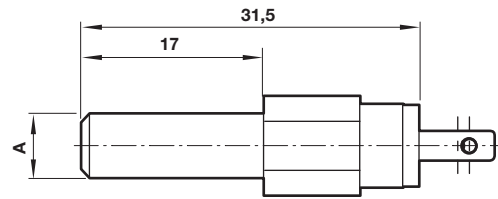

Voltage:	24 V d.c.
Pressure range:	0 ... 10 bar
Switching point rising pressure:	3 ... 5 bar
Switch point falling pressure:	2,5 ... 3,7 bar
AMP E-terminals:	2,8 x 0,8
Degee of protection:	IP00
Adjustment:	None

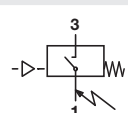

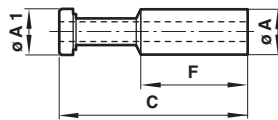
Symbol	A	Short code	Weight (kg)	Model
	4	7A	0,004	VM106517AQ0804
	6	7B	0,004	VM106517AQ0806

**Plug
C0004**

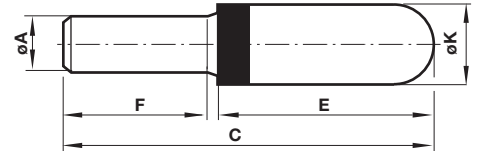
Ø A	Ø A1	C	F	Model
4	4	30	17,5	C00040400
6	6	34	18,5	C00040600
8	8	38	21	C00040800
10	10	42	24	C00041000

Silencer

Ø A	C	E	F	Ø K	Model
4	32	16	14	6,5	T45P0004
6	45	24,5	17	12,5	T45P0006
8	43,5	22	19	13,5	T45P0008
10	57,5	31	23	15,5	T45P0010

Short codes for valve island specifications

Description	Manual override	Short code	Model
2 x 3/2 - 2 x NC - Internal feed valve 3 mm PIF	Turn & lock	NA3T	VM103A11AB213B
2 x 3/2 - 2 x NC - Internal feed valve 3 mm PIF	Push only	NA3U	VM103A11AB313B
2 x 3/2 - 2 x NC - Internal feed valve 4 mm PIF	Turn & lock	NA4T	VM104A11AB213B
2 x 3/2 - 2 x NC - Internal feed valve 4 mm PIF	Push only	NA4U	VM104A11AB313B
2 x 3/2 - 2 x NC - Internal feed valve 6 mm PIF	Turn & lock	NA6T	VM106A11AB213B
2 x 3/2 - 2 x NC - Internal feed valve 6 mm PIF	Push only	NA6U	VM106A11AB313B
2 x 3/2 - 2 x NC - Internal feed valve Pneumapole	Turn & lock	NAZT	VM107A11AB213B
2 x 3/2 - 2 x NC - Internal feed valve Pneumapole	Push only	NAZU	VM107A11AB313B
2 x 3/2 - 2 x NC - External feed valve 3 mm PIF	Turn & lock	ND3T	VM103A22AB213B
2 x 3/2 - 2 x NC - External feed valve 3 mm PIF	Push only	ND3U	VM103A22AB313B
2 x 3/2 - 2 x NC - External feed valve 4 mm PIF	Turn & lock	ND4T	VM104A22AB213B
2 x 3/2 - 2 x NC - External feed valve 4 mm PIF	Push only	ND4U	VM104A22AB313B
2 x 3/2 - 2 x NC - External feed valve 6 mm PIF	Turn & lock	ND6T	VM106A22AB213B
2 x 3/2 - 2 x NC - External feed valve 6 mm PIF	Push only	ND6U	VM106A22AB313B
2 x 3/2 - 2 x NC - External feed valve Pneumapole	Turn & lock	NDZT	VM107A22AB213B
2 x 3/2 - 2 x NC - External feed valve Pneumapole	Push only	NDZU	VM107A22AB313B
2 x 3/2 - 2 x NO - Internal feed valve 3 mm PIF	Turn & lock	NB3T	VM103B11AB213B
2 x 3/2 - 2 x NO - Internal feed valve 3 mm PIF	Push only	NB3U	VM103B11AB313B
2 x 3/2 - 2 x NO - Internal feed valve 4 mm PIF	Turn & lock	NB4T	VM104B11AB213B
2 x 3/2 - 2 x NO - Internal feed valve 4 mm PIF	Push only	NB4U	VM104B11AB313B
2 x 3/2 - 2 x NO - Internal feed valve 6 mm PIF	Turn & lock	NB6T	VM106B11AB213B
2 x 3/2 - 2 x NO - Internal feed valve 6 mm PIF	Push only	NB6U	VM106B11AB313B
2 x 3/2 - 2 x NO - Internal feed valve Pneumapole	Turn & lock	NBZT	VM107B11AB213B
2 x 3/2 - 2 x NO - Internal feed valve Pneumapole	Push only	NBZU	VM107B11AB313B
2 x 3/2 - 2 x NO - External feed valve 3 mm PIF	Turn & lock	NE3T	VM103B22AB213B
2 x 3/2 - 2 x NO - External feed valve 3 mm PIF	Push only	NE3U	VM103B22AB313B
2 x 3/2 - 2 x NO - External feed valve 4 mm PIF	Turn & lock	NE4T	VM104B22AB213B
2 x 3/2 - 2 x NO - External feed valve 4 mm PIF	Push only	NE4U	VM104B22AB313B
2 x 3/2 - 2 x NO - External feed valve 6 mm PIF	Turn & lock	NE6T	VM106B22AB213B
2 x 3/2 - 2 x NO - External feed valve 6 mm PIF	Push only	NE6U	VM106B22AB313B
2 x 3/2 - 2 x NO - External feed valve Pneumapole	Turn & lock	NEZT	VM107B22AB213B
2 x 3/2 - 2 x NO - External feed valve Pneumapole	Push only	NEZU	VM107B22AB313B
2 x 3/2 - 1 x NC + 1 x NO - Internal feed valve 3 mm PIF	Turn & lock	NC3T	VM103C11AB213B
2 x 3/2 - 1 x NC + 1 x NO - Internal feed valve 3 mm PIF	Push only	NC3U	VM103C11AB313B
2 x 3/2 - 1 x NC + 1 x NO - Internal feed valve 4 mm PIF	Turn & lock	NC4T	VM104C11AB213B
2 x 3/2 - 1 x NC + 1 x NO - Internal feed valve 4 mm PIF	Push only	NC4U	VM104C11AB313B
2 x 3/2 - 1 x NC + 1 x NO - Internal feed valve 6 mm PIF	Turn & lock	NC6T	VM106C11AB213B
2 x 3/2 - 1 x NC + 1 x NO - Internal feed valve 6 mm PIF	Push only	NC6U	VM106C11AB313B
2 x 3/2 - 1 x NC + 1 x NO - Internal feed valve Pneumapole	Turn & lock	NCZT	VM107C11AB213B
2 x 3/2 - 1 x NC + 1 x NO - Internal feed valve Pneumapole	Push only	NCZU	VM107C11AB313B
2 x 3/2 - 1 x NC + 1 x NO - External feed valve 3 mm PIF	Turn & lock	NF3T	VM103C22AB213B
2 x 3/2 - 1 x NC + 1 x NO - External feed valve 3 mm PIF	Push only	NF3U	VM103C22AB313B
2 x 3/2 - 1 x NC + 1 x NO - External feed valve 4 mm PIF	Turn & lock	NF4T	VM104C22AB213B
2 x 3/2 - 1 x NC + 1 x NO - External feed valve 4 mm PIF	Push only	NF4U	VM104C22AB313B
2 x 3/2 - 1 x NC + 1 x NO - External feed valve 6 mm PIF	Turn & lock	NF6T	VM106C22AB213B
2 x 3/2 - 1 x NC + 1 x NO - External feed valve 6 mm PIF	Push only	NF6U	VM106C22AB313B
2 x 3/2 - 1 x NC + 1 x NO - External feed valve Pneumapole	Turn & lock	NFZT	VM107C22AB213B
2 x 3/2 - 1 x NC + 1 x NO - External feed valve Pneumapole	Push only	NFZU	VM107C22AB313B

Short codes for valve island specifications

Description	Manual override	Short code	Model
5/2 Solenoid/spring - Internal feed valve 3mm PIF	Turn & lock	NG3T	VM103517AB213B
5/2 Solenoid/spring - Internal feed valve 3mm PIF	Push only	NG3U	VM103517AB313B
5/2 Solenoid/spring - Internal feed valve 4mm PIF	Turn & lock	NG4T	VM104517AB213B
5/2 Solenoid/spring - Internal feed valve 4mm PIF	Push only	NG4U	VM104517AB313B
5/2 Solenoid/spring - Internal feed valve 6mm PIF	Turn & lock	NG6T	VM106517AB213B
5/2 Solenoid/spring - Internal feed valve 6mm PIF	Push only	NG6U	VM106517AB313B
5/2 Solenoid/spring - Internal feed valve Pneumapole	Turn & lock	NGZT	VM107517AB213B
5/2 Solenoid/spring - Internal feed valve Pneumapole	Push only	NGZU	VM107517AB313B
5/2 Solenoid/spring - External feed valve 3 mm PIF	Turn & lock	NH3T	VM103527AB213B
5/2 Solenoid/spring - External feed valve 3 mm PIF	Push only	NH3U	VM103527AB313B
5/2 Solenoid/spring - External feed valve 4 mm PIF	Turn & lock	NH4T	VM104527AB213B
5/2 Solenoid/spring - External feed valve 4 mm PIF	Push only	NH4U	VM104527AB313B
5/2 Solenoid/spring - External feed valve 6 mm PIF	Turn & lock	NH6T	VM106527AB213B
5/2 Solenoid/spring - External feed valve 6 mm PIF	Push only	NH6U	VM106527AB313B
5/2 Solenoid/spring - External feed valve Pneumapole	Turn & lock	NHZT	VM107527AB213B
5/2 Solenoid/spring - External feed valve Pneumapole	Push only	NHZU	VM107527AB313B
5/2 Solenoid/solenoid - Internal feed valve 3 mm PIF	Turn & lock	NJ3T	VM103511AB213B
5/2 Solenoid/solenoid - Internal feed valve 3 mm PIF	Push only	NJ3U	VM103511AB313B
5/2 Solenoid/solenoid - Internal feed valve 4 mm PIF	Turn & lock	NJ4T	VM104511AB213B
5/2 Solenoid/solenoid - Internal feed valve 4 mm PIF	Push only	NJ4U	VM104511AB313B
5/2 Solenoid/solenoid - Internal feed valve 6 mm PIF	Turn & lock	NJ6T	VM106511AB213B
5/2 Solenoid/solenoid - Internal feed valve 6 mm PIF	Push only	NJ6U	VM106511AB313B
5/2 Solenoid/solenoid - Internal feed valve Pneumapole	Turn & lock	NJZT	VM107511AB213B
5/2 Solenoid/solenoid - Internal feed valve Pneumapole	Push only	NJZU	VM107511AB313B
5/2 Solenoid/solenoid - External feed valve 3 mm PIF	Turn & lock	NK3T	VM103522AB213B
5/2 Solenoid/solenoid - External feed valve 3 mm PIF	Push only	NK3U	VM103522AB313B
5/2 Solenoid/solenoid - External feed valve 4 mm PIF	Turn & lock	NK4T	VM104522AB213B
5/2 Solenoid/solenoid - External feed valve 4 mm PIF	Push only	NK4U	VM104522AB313B
5/2 Solenoid/solenoid - External feed valve 6 mm PIF	Turn & lock	NK6T	VM106522AB213B
5/2 Solenoid/solenoid - External feed valve 6 mm PIF	Push only	NK6U	VM106522AB313B
5/2 Solenoid/solenoid - External feed valve Pneumapole	Turn & lock	NKZT	VM107522AB213B
5/2 Solenoid/solenoid - External feed valve Pneumapole	Push only	NKZU	VM107522AB313B
5/3 APB Solenoid/solenoid - Internal feed valve 3 mm PIF	Turn & lock	NL3T	VM103611AB213B
5/3 APB Solenoid/solenoid - Internal feed valve 3 mm PIF	Push only	NL3U	VM103611AB313B
5/3 APB Solenoid/solenoid - Internal feed valve 4 mm PIF	Turn & lock	NL4T	VM104611AB213B
5/3 APB Solenoid/solenoid - Internal feed valve 4 mm PIF	Push only	NL4U	VM104611AB313B
5/3 APB Solenoid/solenoid - Internal feed valve 6 mm PIF	Turn & lock	NL6T	VM106611AB213B
5/3 APB Solenoid/solenoid - Internal feed valve 6 mm PIF	Push only	NL6U	VM106611AB313B
5/3 APB Solenoid/solenoid - Internal feed valve Pneumapole	Turn & lock	NLZT	VM107611AB213B
5/3 APB Solenoid/solenoid - Internal feed valve Pneumapole	Push only	NLZU	VM107611AB313B
5/3 APB Solenoid/solenoid - External feed valve 3 mm PIF	Turn & lock	NM3T	VM103622AB213B
5/3 APB Solenoid/solenoid - External feed valve 3 mm PIF	Push only	NM3U	VM103622AB313B
5/3 APB Solenoid/solenoid - External feed valve 4 mm PIF	Turn & lock	NM4T	VM104622AB213B
5/3 APB Solenoid/solenoid - External feed valve 4 mm PIF	Push only	NM4U	VM104622AB313B
5/3 APB Solenoid/solenoid - External feed valve 6 mm PIF	Turn & lock	NM6T	VM106622AB213B
5/3 APB Solenoid/solenoid - External feed valve 6 mm PIF	Push only	NM6U	VM106622AB313B
5/3 APB Solenoid/solenoid - External feed valve Pneumapole	Turn & lock	NMZT	VM107622AB213B
5/3 APB Solenoid/solenoid - External feed valve Pneumapole	Push only	NMZU	VM107622AB313B

End plates

Description	Manual override	Short code	Model
End plate kit - feed bo h ends	10 mm	F100	VM106517AQ010Y
End plate kit - feed bo h ends	8 mm	F800	VM106517AQ0108
End plate kit - feed left, right blocked	10 mm	L100	VM106517AQ011Y
End plate kit - feed left, right blocked	8 mm	L800	VM106517AQ0118
End plate kit - feed right, left blocked	10 mm	R100	VM106517AQ012Y
End plate kit - feed right, left blocked	8 mm	R800	VM106517AQ0128
End plate kit - feed bo h ends - Pneumapole	no PIF	FPZ0	VM106517AQ0131
End plate kit - feed left, right blocked - Pneumapole	no PIF	RPZ0	VM106517AQ0132
End plate kit - feed right, left blocked - Pneumapole	no PIF	LPZ0	VM106517AQ0133

Warning

These products are intended for use in industrial compressed air systems only. Do not use these products where pressures and temperatures can exceed those listed under

»**Technical features/data**«.

Before using these products with fluids other than those specified, for non-industrial applications, life-support systems or other applications not within published specifications, consult IMI NORGREN.

Through misuse, age, or malfunction, components used in fluid power systems can fail in various modes.

The system designer is warned to consider the failure modes of all component parts used in fluid power systems and to provide adequate safeguards to prevent personal injury or damage to equipment in the event of such failure.

System designers must provide a warning to end users in the system instructional manual if protection against a failure mode cannot be adequately provided.

System designers and end users are cautioned to review specific warnings found in instruction sheets packed and shipped with these products.